

# JVC

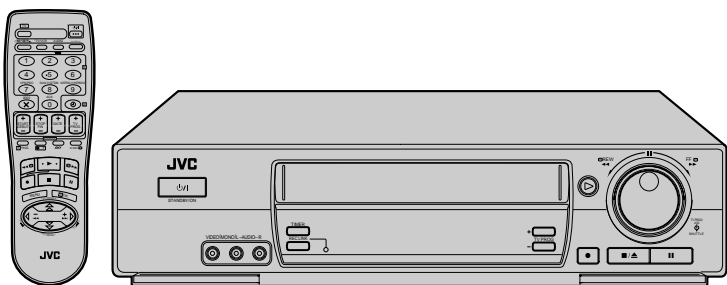

## VIDEO CASSETTE RECORDER

# HR-J765EK



**VIDEO** *Plus+* *Hi-Fi* **VHS** PAL

## INSTRUCTIONS

### CONTENTS

<b>SAFETY FIRST</b>	<b>2</b>
Safety Precautions .....	2
Some Do's And Don'ts .....	3
<b>QUICK SET UP GUIDE</b>	<b>4</b>
CHECK THE CONTENTS .....	4
INSTALLATION .....	5
AUTO SET UP .....	6
<b>BASIC OPERATIONS</b>	<b>8</b>
Playback .....	8
Recording .....	10
VIDEO Plus+ Timer Programming .....	12
Express Timer Programming .....	14
<b>ADVANCED OPERATIONS</b>	<b>17</b>
Playback Picture Adjustment ....	17
Playback/Recording According To Tape Characteristics .....	18
Selecting The Sound You Want .....	20
Looking For The Scene You Want .....	21
Automatic Satellite Programme Recording .....	22
Edit To Or From Another Video Recorder .....	24
Edit From A Camcorder .....	25
Other Functions .....	26
<b>SYSTEM CONNECTIONS</b>	<b>29</b>
Connection To A Stereo System .....	29
<b>SUBSIDIARY SETTINGS</b>	<b>30</b>
Video Channel Set .....	30
Tuner Set .....	32
Clock Set .....	39
VIDEO Plus+ Setup .....	40
<b>SUBSIDIARY INFORMATION</b>	<b>41</b>
Questions And Answers .....	41
Troubleshooting .....	42
Index .....	44
<b>SPECIFICATIONS</b>	<b>Back Cover</b>

# Safety Precautions

The rating plate and the safety caution are on the rear of the unit.

**WARNING: DANGEROUS VOLTAGE INSIDE**

**WARNING: TO PREVENT FIRE OR SHOCK HAZARD, DO NOT EXPOSE THIS UNIT TO RAIN OR MOISTURE.**

## IMPORTANT

- Please read the various precautions on p. 2 – 3 of this instruction manual before installing or operating the recorder.
- It should be noted that it may be unlawful to re-record pre-recorded tapes, records, or discs without the consent of the owner of copyright in the sound or video recording, broadcast or cable programme and in any literary, dramatic, musical, or artistic work embodied therein.

## IMPORTANT

**Connection to the mains supply in the United Kingdom. DO NOT cut off the mains plug from this equipment.** If the plug fitted is not suitable for the power points in your home or the cable is too short to reach a power point, then obtain a proper safety approved extension lead/adaptor or consult your dealer.

**In the unlikely event of the plug fuse failing be sure to replace the fuse only with an identical approved type, as originally fitted, and to replace the fuse cover. If the fuse fails again consult your nearest JVC dealer.**

If nonetheless the mains plug is cut off remove the fuse and dispose of the plug immediately, to avoid a possible shock hazard by inadvertent connection to the mains supply.

If this product is not supplied fitted with a mains plug then follow the instructions given below:

**DO NOT** make any connection to the Larger Terminal coded E or Green.

The wires in the mains lead are coloured in accordance with the following code:

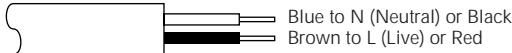

If these colours do not correspond with the terminal identifications of your plug, connect as follows:  
Blue wire to terminal coded N (Neutral) or coloured Black.  
Brown wire to terminal coded L (Live) or coloured Red.

**If in doubt — consult a competent electrician.**

## CAUTION

- When you are not using the recorder for a long period of time, it is recommended that you disconnect the power cord from the mains outlet.
- Dangerous voltage inside. Refer internal servicing to qualified service personnel. To prevent electric shock or fire hazard, remove the power cord from the mains outlet prior to connecting or disconnecting any signal lead or aerial.

The STANDBY/ON  $\text{O/I}$  button does not completely shut off mains power from the unit, but switches operating current on and off. "  $\text{O}$  " shows electrical power standby and "  $\text{I}$  " shows ON.

Video tapes recorded with this video recorder in the LP (Long Play) mode cannot be played back on a single-speed video recorder.

**Failure to heed the following precautions may result in damage to the recorder, remote control or video cassette.**

1. **DO NOT** place the recorder . . .
  - ... in an environment prone to extreme temperatures or humidity.
  - ... in direct sunlight.
  - ... in a dusty environment.
  - ... in an environment where strong magnetic fields are generated.
  - ... on a surface that is unstable or subject to vibration.
2. **DO NOT** block the recorder's ventilation openings.
3. **DO NOT** place heavy objects on the recorder or remote control.
4. **DO NOT** place anything which might spill on top of the recorder or remote control.
5. **AVOID** violent shocks to the recorder during transport.

## MOISTURE CONDENSATION

Moisture in the air will condense on the recorder when you move it from a cold place to a warm place, or under extremely humid conditions—just as water droplets form in the surface of a glass filled with cold liquid. Moisture condensation on the head drum will cause damage to the tape. In conditions where condensation may occur, keep the recorder turned on for a few hours to let the moisture dry.

## ABOUT HEAD CLEANING

Accumulation of dirt and other particles on the video heads may cause the playback picture to become blurred or interrupted. Be sure to contact your nearest JVC dealer if such troubles occur.



- Cassettes marked "VHS" (or "S-VHS") can be used with this video recorder. However, only VHS recordings can be made and played back.
- HQ VHS is compatible with existing VHS equipment.
- VIDEO Plus+ and PlusCode are registered trademarks of Gemstar Development Corporation. The VIDEO Plus+ system is manufactured under license from Gemstar Development Corporation.

# Some Do's And Don'ts On The Safe Use Of Equipment

This equipment has been designed and manufactured to meet international safety standards but, like any electrical equipment, care must be taken if you are to obtain the best results and safety is to be assured.

- DO** read the operating instructions before you attempt to use the equipment.
- DO** ensure that all electrical connections (including the mains plug, extension leads and interconnections between pieces of equipment) are properly made and in accordance with the manufacturer's instructions. Switch off and withdraw the mains plug when making or changing connections.
- DO** consult your dealer if you are ever in doubt about the installation, operation or safety of your equipment.
- DO** be careful with glass panels or doors on equipment.
- DON'T** continue to operate the equipment if you are in any doubt about it working normally, or if it is damaged in any way — switch off, withdraw the mains plug and consult your dealer.
- DON'T** remove any fixed cover as this may expose dangerous voltages.
- DON'T** leave equipment switched on when it is unattended unless it is specifically stated that it is designed for unattended operation or has a standby mode. Switch off using the switch on the equipment and make sure that your family knows how to do this. Special arrangements may need to be made for infirm or handicapped people.
- DON'T** use equipment such as personal stereos or radios so that you are distracted from the requirements of road safety. It is illegal to watch television whilst driving.
- DON'T** listen to headphones at high volume, as such use can permanently damage your hearing.
- DON'T** obstruct the ventilation of the equipment, for example with curtains or soft furnishings. Overheating will cause damage and shorten the life of the equipment.
- DON'T** use makeshift stands and NEVER fix legs with wood screws — to ensure complete safety always fit the manufacturer's approved stand or legs with the fixings provided according to the instructions.
- DON'T** allow electrical equipment to be exposed to rain or moisture.

## ABOVE ALL...

- **NEVER** let anyone especially children push anything into holes, slots or any other opening in the case — this could result in a fatal electrical shock;
- **NEVER** guess or take chances with electrical equipment of any kind — it is better to be safe than sorry!

## ► Dear Customer,

Thank you for purchasing this JVC Video Cassette Recorder.  
Please use this **QUICK SET UP GUIDE** to help you to set up your video cassette recorder.

**STEP**
**1**

## CHECK THE CONTENTS

### CHECK ALL THE CONTENTS SHOWN BELOW



Video Cassette Recorder

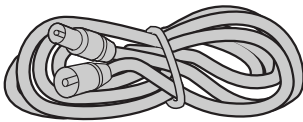

RF Cable

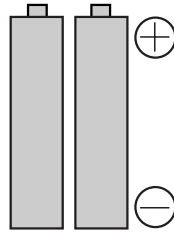

"AA" Batteries (x 2)

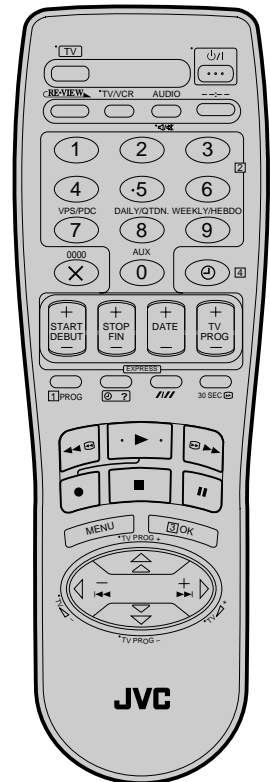

Infrared Remote Control Unit

► You are now ready to install your video recorder.

## STEP

## 2

## INSTALLATION

## CONNECT VIDEO RECORDER TO TV

- Place the recorder on a stable, flat surface.

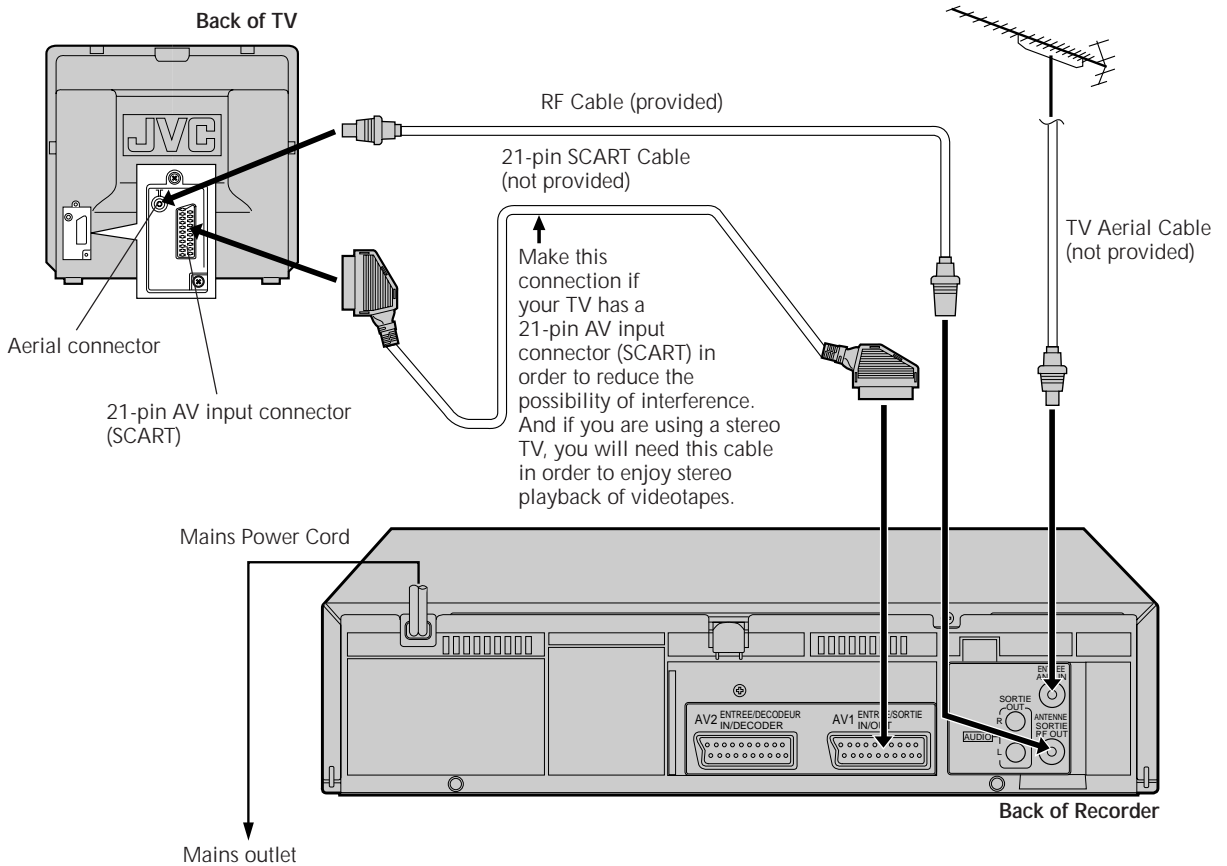
**RF CONNECTION**

To Connect To A TV With NO 21-pin AV input connector (SCART) . . .

- 1- Disconnect the TV aerial cable from the TV.
- 2- Connect the TV aerial cable to the ANT. IN jack on the rear panel of the recorder.
- 3- Connect the provided RF cable between the RF. OUT jack on the rear panel of the recorder and the TV's aerial connector.

**AV CONNECTION**

To Connect To A TV With 21-pin AV input connector (SCART) . . .

- 1- Connect the aerial, recorder and TV as per "RF CONNECTION".
- 2- Connect an optional SCART cable between the AV1 IN/OUT connector on the rear panel of the recorder and the TV's 21-pin AV input connector (SCART).

**ATTENTION**

- Do NOT Plug the mains power cord into a mains outlet until all connections are completed.
- Do NOT press the  $\phi$ /I button on the recorder or on the remote control to turn on the recorder's power before you start the Auto Set Up procedure described on page 6.

AFTER YOU FINISH THIS STEP

Go to Step 3 – AUTO SET UP

## STEP

## 3 AUTO SET UP

## SET THE TUNER CHANNELS, CLOCK, GUIDE PROGRAM NUMBERS AND VIDEO CHANNEL\*

The Auto Set Up function sets the tuner channels, clock, VIDEO Plus+ assigned Guide Program numbers and the video channel\* automatically the first time the  $\psi/1$  button on the recorder or on the remote is pressed to turn on the recorder after the mains power cord has been plugged into a mains outlet.

\* Useful if you have connected the video recorder to your TV via RF connection (see pg. 5). Video Channel (RF output channel) is the channel on which your TV receives picture and sound signals from the video recorder through the RF cable.

**Before performing the following procedure, make sure that:**

- the TV aerial cable is connected to the recorder.
- the mains power cord is plugged into the mains outlet.
- batteries have been installed in the remote control.

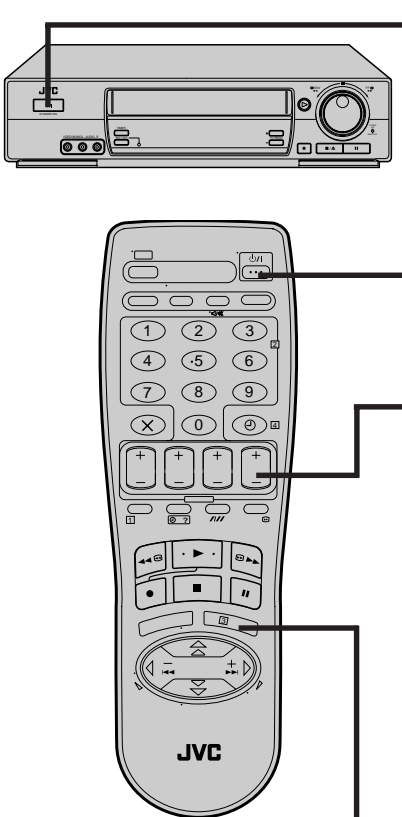

**1** Press  $\psi/1$ .  
"Auto" appears on the display panel and blinks; do NOT press any button on the recorder or remote control until the display panel shows either the display as illustrated below in item **2** or "-- :--". Auto Set Up usually takes about 4 – 12 minutes; the duration varies by area.

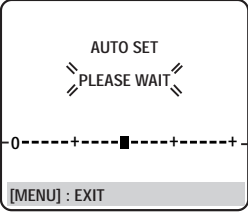

- If "-- :--" appears on the display panel, refer to next page.
- If you have connected the video recorder to your TV via both an RF cable and a 21-pin SCART cable (AV connection) and if the TV is turned on and set to its AV mode, the AUTO SET screen will appear.

Beginning 0 End  
[MENU] : EXIT

**2**

- **If you have connected the video recorder to your TV via an RF cable only (RF connection)** — the channel that is shown on the display panel is your Video Channel. To view picture signals from the video recorder, set your TV to the Video Channel. — Refer to the instructions supplied with your TV set for how to do this.  
Go to item **3**.
- **If you have connected the video recorder to your TV via both an RF cable and a 21-pin SCART cable (AV connection)** — you do not need the video channel so you have to set the video channel to off. Press TV PROG — until the display panel shows "\_OUT—" to set the Video Channel to off. To view picture signals from the video recorder, set your TV to its AV mode. — Refer to the instructions supplied with your TV set for how to do this.  
Go to item **3**.

**3** Press OK to finish Auto Set Up and refer to next page to check the results.

## ATTENTION

Once you have performed Auto Set Up, all the stored stations, Guide Program numbers and the video channel remain in the recorder's memory and the recorder will not perform Auto Set Up again. If there is a power cut and the recorder's memory backup expires you only need to reset the clock. (see pg. 39)

If you have moved to a different area, perform each setting as required.

- Video Channel setting (for RF connection users) see pg. 30
- Tuner setting see pg. 32
- Clock setting see pg. 39

If a new station begins broadcasting in your area, perform tuner setting (see pg. 32) and, if necessary, video channel setting (see pg. 30).

## NOTES:

- Auto channel set function takes place first; it assigns automatically all receivable stations in your area.
- Auto clock set function sets the clock automatically.
- During auto channel set, the recorder recognizes each station name of the detected stations and stores them in the recorder's memory, then automatically sets the VIDEO Plus+ assigned Guide Program number for those stations according to the broadcast area.
- **For RF connection users:** The video recorder detects the channels which are not occupied by local stations and selects one channel automatically for your Video Channel that is located in the middle of more than 5 vacant channels.
- If there is power cut or if you press  $\psi/1$  or MENU while Auto Set Up is in progress, Auto Set Up will be interrupted; be sure to turn off the recorder power once and press  $\psi/1$  to turn the power back on in order to re-start Auto Set Up.

## Auto Set Up results appear on the display panel



**A** When both auto channel set and auto clock set have been completed successfully the correct current time will be displayed after the **OK** button is pressed in item **3** on page 6.



**B** When auto channel set has been completed successfully but auto clock set has not, "(PR)1" will be displayed after the **OK** button is pressed in item **3** on page 6.



**C** When neither auto channel set nor auto clock set has been completed successfully, "--:--" will be displayed.

\* You can check if the Guide Program numbers have been set correctly when you perform VIDEO Plus+ Timer Programming (☞ pg. 12); if the correct preset position number is displayed in step **3**, this confirms that the Guide Program number for the PlusCode number you enter in step **2** has been set correctly.

### **A** If both auto channel set and auto clock set have been performed successfully:

- 1 Turn on the TV and select its VIDEO channel or AV mode, then make sure that all necessary stations have been stored in the recorder's memory by using the **TV PROG** button(s).
  - If station names (ID — ☞ pg. 37) have also been stored in the recorder's memory, the station name will be displayed at the top left corner of the screen for about 5 seconds each time the recorder is tuned to a different station.
  - If you want to set the tuner manually such as to add or skip channels, to change preset positions, or to set or change station names, see pages 34 – 36.

*Now you have finished the basic set up and can use your recorder for both playback and recording.*

### **B** If auto channel set has succeeded but auto clock set has not:

- 1 Turn on the TV and select its VIDEO channel or AV mode, then make sure that all necessary stations have been stored in the recorder's memory by using the **TV PROG** button(s).
  - If station names (ID — ☞ pg. 37) have also been stored in the recorder's memory, the station name will be displayed at the top left corner of the screen for about 5 seconds each time the recorder is tuned to a different station.
  - If you want to set the tuner manually such as to add or skip channels, to change preset positions, or to set or change station names, see pages 34 – 36.
- 2 Perform "Clock Set" on page 39.

*Now you have finished the basic set up and can use your recorder for both playback and recording.*

### **C** If both auto channel set and auto clock set have failed:

- 1 Make sure the TV aerial cable is connected properly to the recorder and turn off the recorder power once, then turn the recorder power back on again.
  - The recorder will try Auto Set Up again.

## IMPORTANT

- In certain reception conditions, station names may not be stored correctly, and auto Guide Program Number Set may not work properly. If the Guide Program numbers are not set properly, when you timer-record a TV programme using VIDEO Plus+, the recorder will record a TV programme of a different station. When programming the timer using VIDEO Plus+, be sure to check that the preset position corresponding to the broadcasting station you wish to record has been selected (☞ pg. 12, "VIDEO Plus+ Timer Programming").
- Your video recorder memorizes all detected stations even if reception of some of them is poor. In these cases picture quality may be poor. To delete those stations which have an unacceptable picture ☞ "Delete A Channel" on page 35.
- If any of the above problems occur, refer to pages 34 – 36 to input station names (☞ "Set Stations") or delete unnecessary stations (☞ "Delete A Channel"). You can also change station preset positions (☞ "Change Station Preset Position").
- **For RF connection users:** In certain reception conditions, the Video Channel may not be set correctly and interference may appear in the TV picture while the recorder's power is on. Set your Video Channel manually. ☞ pg. 30, "Video Channel Set".

If you have any difficulty with the above procedures call the JVC Customer Service Hot Line on 0181 208 7654



# Playback

Turn on the TV and select the VIDEO channel (or AV mode).

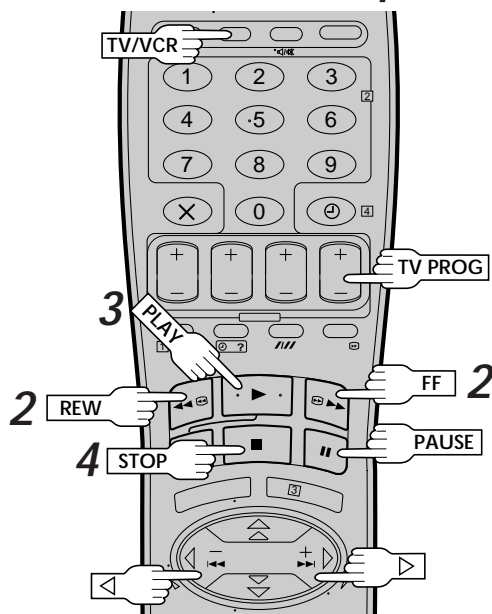
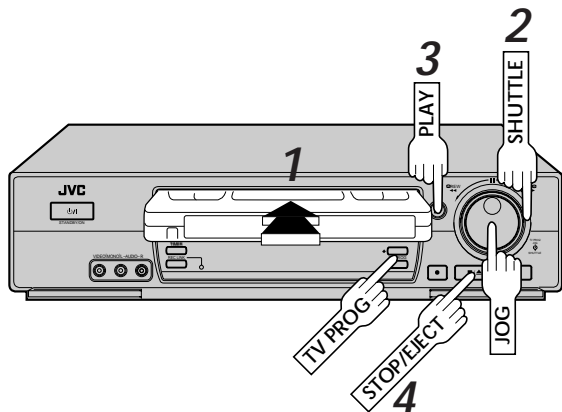

## Tape Position Indicator

The tape position indicator appears on screen when, from the Stop mode, you press **FF**, **REW** or perform an Index Search. The position of "■" in relation to "0" (beginning) or "+" (end) shows you where you are on the tape.

"O.S.D." (pg. 26) must be set to "ON", or the indicator will not appear.

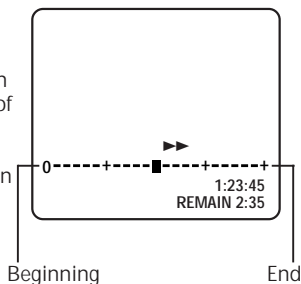

### NOTE:

Depending on the type of tape used, there may be times when the indication is not correct.

The easiest, most basic operation possible with your video recorder is tape playback. Already-recorded signals on a video tape are read by your video recorder and displayed on your TV just like a TV programme.

## 1 LOAD A CASSETTE

Make sure the window side is up, the rear label side is facing you and the arrow on the front of the cassette is point toward the recorder. Don't apply too much pressure when inserting.

- The recorder power comes on automatically and the counter is reset to 0:00:00.
- If the record safety tab has been removed, playback begins automatically.

## 2 FIND PROGRAMME START POINT

If the tape is advanced past the start point, press **REW** or turn the **SHUTTLE** ring to the left.

To go forward, press **FF** or turn the **SHUTTLE** ring to the right.

## 3 START PLAYBACK

Press **PLAY**. "BEST" appears blinking in the recorder's display panel during automatic tracking (pg. 18).

- Playback picture quality of LP recordings will not be as high as SP recordings.

## 4 STOP PLAYBACK

Press **STOP** on the remote or **STOP/EJECT** on the recorder's front panel. Then press **STOP/EJECT** to remove the cassette.

## INFORMATION

When using the AV connection (pg. 5), initiating playback causes the VCR indicator to light and the TV to automatically enter AV mode. To return the TV to TV mode after playback is complete, press **TV/VCR** so that the VCR indicator turns off.

\* Depending on the type of TV used, **TV/VCR** button does not function as described above.

## Usable cassettes

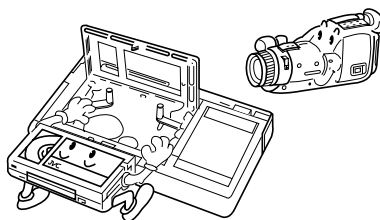

- Compact VHS camcorder recordings can be played on this video recorder. Simply place the recorded cassette into a VHS Cassette Adapter and it can be used just like any full-sized VHS cassette.
- This video recorder can record on regular VHS and Super VHS cassettes. However, it will record and play back regular VHS signals only. It is not possible to play back a recorded Super VHS tape.



**NOTE:**

Refer to the **SHUTTLE** ring illustration below as you read the following procedures.

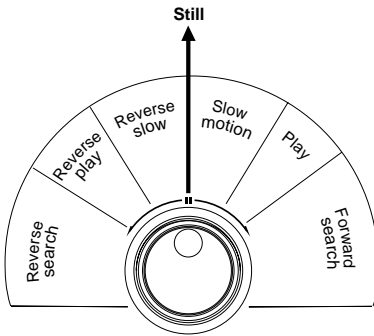
**Variable-Speed Search****1 ACTIVATE VARIABLE-SPEED SEARCH**

During playback or still, turn the **SHUTTLE** ring to the right for forward variable-speed search, or to the left for reverse variable-speed search (refer to the illustration at left).

**OR**

During playback, press ◀ or ▶.

- The more times you press, the faster the playback picture moves.
- To decrease speed, press the button for the opposite direction.

To resume normal playback, press **PLAY**.

**High-Speed Search****1 ACTIVATE HIGH-SPEED SEARCH**

During playback or still, turn the **SHUTTLE** ring all the way to the right for forward high-speed search, or to the left for reverse high-speed search. Releasing **SHUTTLE** resumes still picture playback.

**OR**

- For forward high-speed search, turn the **SHUTTLE** ring all the way to the right and release it within 1 second.
- For reverse high-speed search, turn the **SHUTTLE** ring all the way to the left and release it within 1 second.

**OR**

During playback or still picture, press **FF** for forward high-speed search, or **REW** for reverse high-speed search.

To resume normal playback, press **PLAY**.

**NOTE:**

For short searches, press and hold **FF** or **REW** for more than 2 seconds during playback or still picture. When released, normal playback resumes.

**ATTENTION**

In the search, still, slow-motion or frame-by-frame playback mode,

- the picture will be distorted.
- noise bars will appear.
- there will be loss of colour with a tape recorded in LP mode.

**Still Picture/Frame-By-Frame Playback****1 PAUSE DURING PLAYBACK**

Press **PAUSE**. If there is vertical jitter, use the **TV PROG** buttons to correct the picture.

**2 ACTIVATE FRAME-BY-FRAME PLAYBACK**

Turn the **JOG** dial to the right for forward frame-by-frame playback, or to the left for reverse frame-by-frame playback.

**OR**

Press **PAUSE**. Each time **PAUSE** is pressed the tape will advance one frame.

**OR**

Press ◀ or ▶. Each time one of these buttons is pressed the tape will move one frame in the direction of the arrow.

To resume normal playback, press **PLAY**.

**Slow Motion****1 ACTIVATE SLOW-MOTION PLAYBACK**

During playback or still picture, turn the **SHUTTLE** ring to the right for forward slow motion, or to the left for reverse slow motion (refer to the illustration above).

**OR**

During still picture, press and hold **PAUSE** for 2 seconds, then release. Press and release again to return to still picture.

**OR**

During still picture, press and hold ◀ or ▶. Release to return to still picture.

To resume normal playback, press **PLAY**.

# Recording

Turn on the TV and select the VIDEO channel (or AV mode).

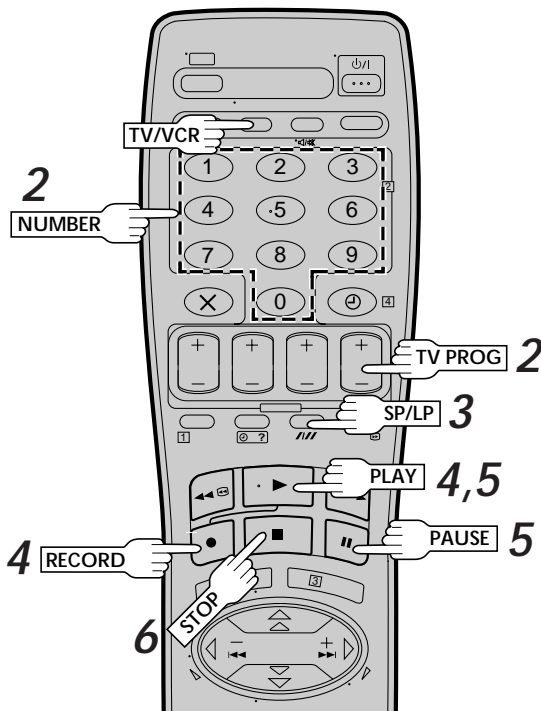
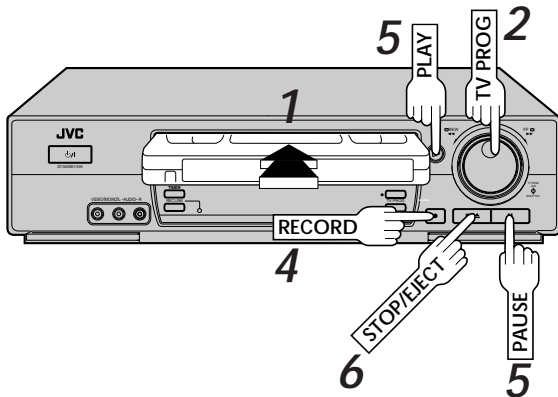

## INFORMATION

When using the AV connection (see pg. 5), you can switch between TV mode and AV mode by pressing **TV/VCR**.

\* Depending on the type of TV used, **TV/VCR** button does not function as described above.

## Recording Resume Function

If there is a power outage during recording (or Instant Timer Recording or timer recording), the recording will resume automatically when power is restored to the recorder unless the recorder's memory backup has expired.

TV signals being received by the recorder's built-in tuner can be recorded onto a video tape. You can "capture" a TV programme using your video recorder.

## 1 LOAD A CASSETTE

Insert a cassette with the record safety tab intact (See below).

- The counter is reset to 0:00:00 and the recorder power comes on automatically.

## 2 CHOOSE A PROGRAMME

Press **TV PROG +/-** or the **NUMBER** keys to select the preset you wish to record.

- The **TV PROG** dial can also be used to select a preset.

## 3 SET TAPE SPEED

Press **SP/LP (//)**. Check the SP/LP indicator on the recorder display panel to confirm the selected tape speed.

- Picture quality of LP recordings will not be as high as on SP recordings.

## 4 START RECORDING

Press and hold **RECORD** and press **PLAY** on the remote control, or press **RECORD** on the recorder.

B.E.S.T. takes place at the beginning of both the first SP and the first LP recording after inserting the cassette (see pg. 18).

- You can not change the preset whilst recording is in progress. To change the preset, see step 5.

## 5 PAUSE/RESUME RECORDING

Press **PAUSE**. Press **PLAY** to resume recording.

- During the Record Pause mode, you can change the preset by pressing the **TV PROG +/-** buttons or the **NUMBER** keys or by turning the **TV PROG** dial.

## 6 STOP RECORDING

Press **STOP** on the remote control or **STOP/EJECT** on the recorder. Then press **STOP/EJECT** to remove the cassette.

## Accidental erasure prevention

- To prevent accidental recording on a recorded cassette, remove its safety tab. To record on it later, cover the hole with adhesive tape.

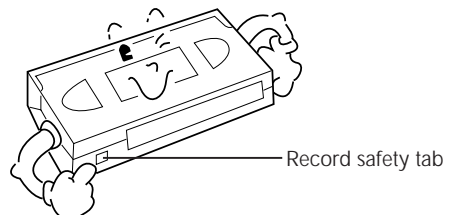

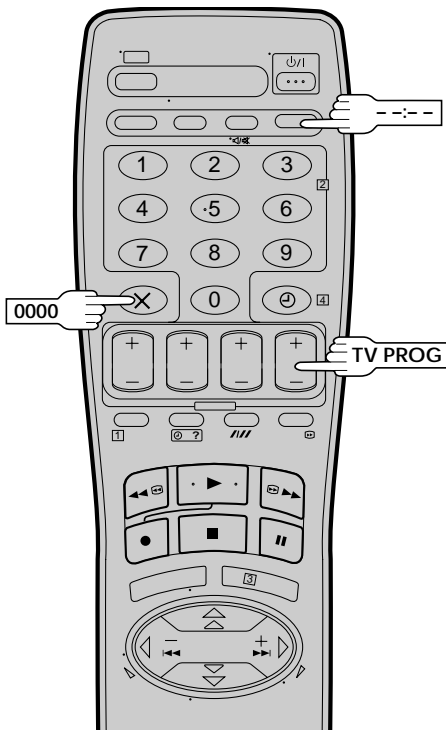
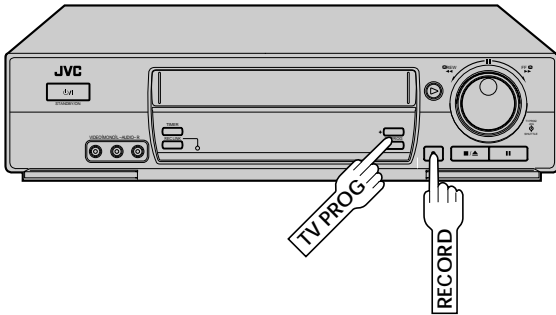

## Record One Programme While Watching Another

1

### SELECT PRESET TO WATCH

Once recording is in progress, all you need to do is to set the preset controls on the TV for the station you wish to view.

- The programme selected with the TV's preset controls appears on the TV screen while the one selected with the recorder's **TV PROG** buttons is recorded on the tape.

## Elapsed Recording Time Indication

You can check the exact time of a recording.

1

### SET COUNTER DISPLAY

Press **--:--** until a counter reading appears on the display panel.

2

### RESET COUNTER

Press **0000** before starting recording or playback.

- The counter is reset to "0:00:00" and shows the exact elapsed time as the tape runs.

## Instant Timer Recording (ITR)

This easy method allows you to record for any length of time from 30 mins. to 6 hours (selectable in 30-min. increments), and shuts off the recorder after recording is finished.

1

### START RECORDING

Press **RECORD** on the recorder.

2

### ENGAGE ITR MODE

Press **RECORD** again. "⦿" blinks and "0:30" appears on the front display panel.

3

### SET RECORDING DURATION

If you want to record for more than 30 minutes, press **RECORD** to extend the time. Each press extends recording time by 30 minutes.

### NOTE:

You can only perform ITR using the **RECORD** button on the recorder's front panel.

## Tape Remaining Time

1

### DISPLAY REMAINING TIME

Press **--:--** until the time remaining on the tape appears.

- The display panel shows the tape remaining time with "▶" displayed.
- By pressing the **--:--** button, you can change the display to show the counter reading, preset position\*, clock time or tape remaining time.

\* Preset position is not displayed during playback.

### NOTE:

Depending on the type of tape used, there may be times when the tape remaining time reading may not appear right away, or is not correct. "--:--" may sometimes appear, or the display may blink on occasion.

# VIDEO Plus+ Timer Programming

## Before performing VIDEO Plus+ Timer Programming:

- Make sure that the recorder's built-in clock is set properly.
- Insert a cassette with the safety tab in place. The recorder will come on automatically.
- Turn on the TV and select the VIDEO channel (or AV mode).

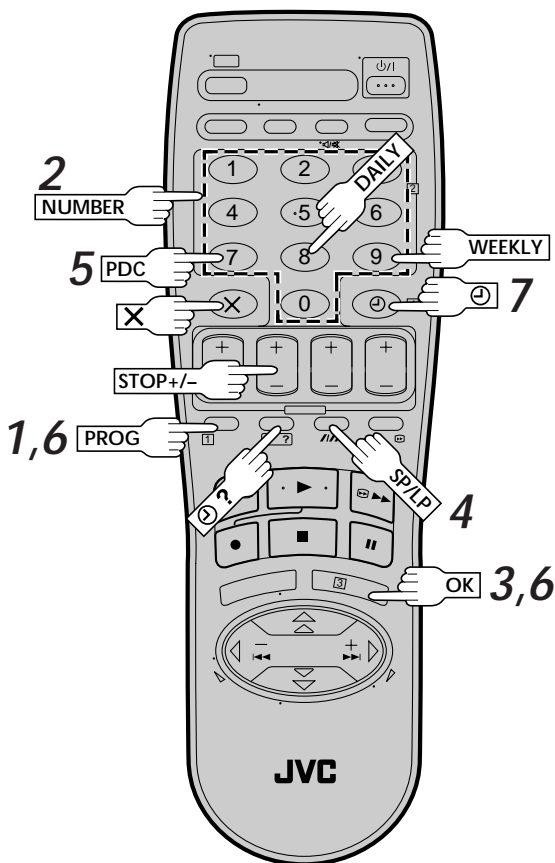

With VIDEO Plus+, timer programming is greatly simplified because each TV programme has a corresponding code number which your recorder is able to recognise.

1

## ACCESS VIDEO PLUS+ SCREEN

Press **PROG**.

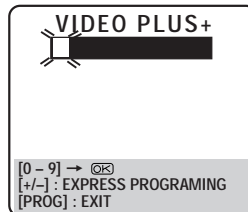

The front display panel looks like this:



2

## ENTER PLUSCODE NUMBER

Press the **NUMBER** keys to enter the PlusCode number of the programme you wish to record.

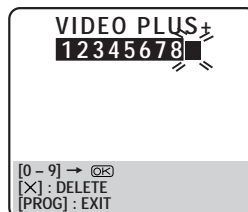

- If you make a mistake, press **X** and input the correct number.

The PlusCode number you enter appears on the front display panel:



The display panel shows only a 4-digit number.

3

## ACCESS VIDEO PLUS+ PROGRAM SCREEN

Press **OK**, and the VIDEO Plus+ Program screen appears (if you're just starting out, "P1" appears).

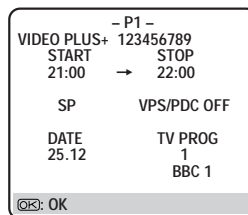

The display panel shows the programme start time. Pressing **?** changes the display to the programme stop time, then the date and preset position.



### IMPORTANT

Make sure the preset position number you wish to record is displayed; if not, see "VIDEO Plus+ Setup" on page 40 and set the Guide Program number for that PlusCode number correctly.

- If the number you entered is invalid, "ERROR" appears on the screen and "Err" appears on the display panel. Press **X** and input a valid PlusCode number.
- If the "GUIDE PROG SET" screen appears, see "ATTENTION - Regarding Guide Program Number Set" on page 13.

4

## SET TAPE SPEED

Press **SP/LP (//)** to set the tape speed.

5

## SET PDC MODE

Press **PDC** to select "ON" or "OFF".

If "VPS/PDC ON" is displayed on the screen or "VPS/PDC" is lit on the display panel, PDC is set to ON.

If "VPS/PDC OFF" is displayed on the screen or "VPS/PDC" is not lit on the display panel, PDC is set to OFF. ⇨ "PDC Recording" in the column below.

- VPS (Video Programme System) recording is not currently available in the U.K. and not possible with this recorder.

6

## RETURN TO NORMAL SCREEN

Press **PROG** or **OK**. "PROGRAM COMPLETED" appears on the screen for about 5 seconds, then normal screen appears.

- Repeat steps 1 – 6 for each additional programme.

7

## ENGAGE RECORDER'S TIMER MODE

Press **⊖ (TIMER)**. The recorder turns off automatically and **⊖** appears on the display panel.

- To disengage the timer, press **⊕ (TIMER)** again.

## NOTES:

- To Change The Stop Time . . .  
... press **STOP +/-** after pressing **OK** in step 3. You can compensate for anticipated programme schedule delays this way.
- To Timer-Record Weekly Or Daily Serials . . .  
... after pressing **OK** in step 3, press **WEEKLY** (NUMBER key "9") for weekly serials or **DAILY** (NUMBER key "8") for daily serials (Monday – Friday). Either "WEEKLY" or "DAILY" appears on the screen. Pressing the button again makes the corresponding indication disappear.
- You can programme this recorder to timer-record as many as 8 programmes. If you try to programme the recorder to record a ninth, "PROGRAM FULL" appears on screen and "FULL" appears on the front display panel. To record the extra programme, you must first cancel any unnecessary programmes (⇨ pg. 16).
- It is not possible to timer-record a TV programme with a PlusCode number which starts with "0".

### Satellite Receiver Users

To timer-record a satellite broadcast using VIDEO Plus+:

- 1 Perform steps 1 – 7.
- 2 Set the satellite receiver to the appropriate channel before the selected programme begins.
- 3 Leave the satellite receiver's power on.

## ATTENTION

### Regarding Guide Program Number Set

"GUIDE PROG SET" appears after performing step 3 if the Guide Program number for the PlusCode number you entered has not been set.

- Press the **NUMBER** keys or **Δ∇** to input the preset position number on which your recorder receives that station, then press **OK** or **▷** to set the Guide Program number. The VIDEO Plus+ Program screen appears.

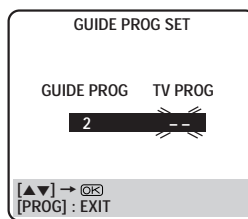

(Ex.) To timer-record a BBC2 programme with VIDEO Plus+.  
\* If your recorder receives BBC2 on the preset position 2, press **OK** or **▷** after entering "2".

## Timer Warning

If you have programmed your recorder to timer-record a programme or a series of programmes, a warning appears on the screen to tell you that the recording is due to start in 5 minutes.



### NOTES:

- The warning only appears if you're not in the Timer mode at the time.
- If this recorder is being used as the player for tape dubbing, the warning screen will be recorded on the tape in the other video recorder.

The warning blinks for the entire 5 minutes leading up to the start of timer recording. To clear the display, press **X**.

## PDC Recording

Now available from some TV stations, PDC (Programme Delivery Control) is a service designed to assure safe, accurate timer recording. With this system, special code signals are transmitted together with the audio/video signals. These code signals control your video recorder and have precedence over the advertised times which you may have preset into the timer. This means that your recorder will start and stop recording when the preset TV programmes actually start and end — even if the broadcast time of a preset TV programme is changed from what has been advertised. PDC is currently available nationally on BBC1, BBC2, Ch.4 and Ch.5, except from a few small relay transmitters. Ch.3 operates a PDC service only in a very few areas. All channels intend to offer this service in due course. Check your TV programme listing guide for latest information. If the channel you intend to record does not offer a PDC service your recorder will not start recording if PDC has been selected. Be sure to set PDC to "OFF" if PDC is not available on your selected channel (⇨ step 5 above).

### NOTES:

- PDC recording is also possible when a satellite receiver or a cable system is connected to AV2 IN/DECODER on your recorder.
- PDC recording is also possible via the AV1 IN/OUT connector and the front panel connectors.

# Express Timer Programming

## Before performing Express Timer Programming:

- Make sure that the recorder's built-in clock is set properly.
- Insert a cassette with the safety tab in place. The recorder will come on automatically.
- Turn on the TV and select the VIDEO channel (or AV mode).

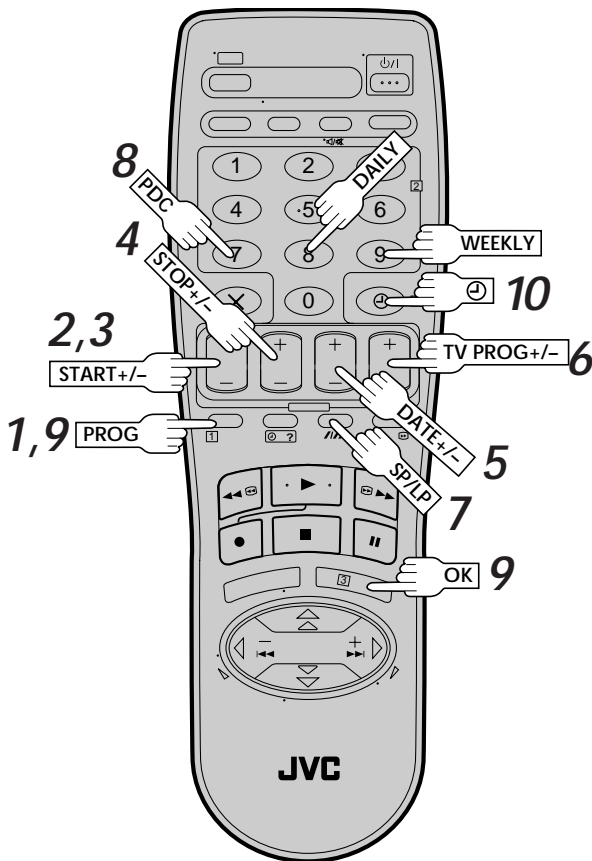

If you don't know the PlusCode number for the programme you wish to record, use the following procedure to set your recorder to timer-record the programme.

## 1 ACCESS VIDEO PLUS+ SCREEN

Press **PROG**.

## 2 ACCESS PROGRAMME SCREEN

Press **START +/-**. (If you're just starting out, "P1" appears.)

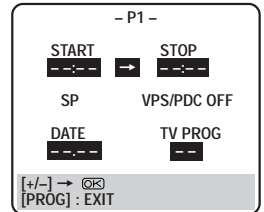

The front display panel looks like this:



## 3 ENTER PROGRAMME START TIME

Press **START +/-** to enter the time you want recording to start.

- Press and hold **START +/-** to move in 30-minute increments, or press and release repeatedly to move 1 minute at a time.

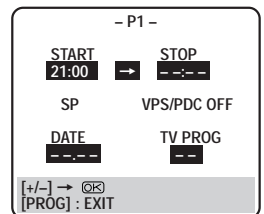

The front display panel looks like this:



## 4 ENTER PROGRAMME STOP TIME

Press **STOP +/-** to enter the time you want recording to stop.

- Press and hold **STOP +/-** to move in 30-minute increments, or press and release repeatedly to move 1 minute at a time.

## 5 ENTER PROGRAMME DATE

Press **DATE +/-** to enter the date on which you wish to record. (The current date first appears on screen. The date you enter will appear in its place.)



6

## ENTER PRESET POSITION

Press **TV PROG +/-** to enter the preset position corresponding to the broadcasting station you wish to record.

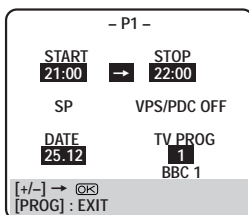

7

## SET TAPE SPEED

Press **SP/LP (||||)** to set the tape speed.

8

## SET PDC MODE

Press **PDC** to select "ON" or "OFF".

If "VPS/PDC ON" is displayed on the screen or "VPS/PDC" is lit on the display panel, PDC is set to ON.

If "VPS/PDC OFF" is displayed on the screen or "VPS/PDC" is not lit on the display panel, PDC is set to OFF.

☞ "PDC Recording" in the right column.

- VPS (Video Programme System) recording is not currently available in the U.K. and not possible with this recorder.

9

## RETURN TO NORMAL SCREEN

After confirming all information is correct, press **PROG** or **OK**. "PROGRAM COMPLETED" appears on the screen for about 5 seconds, then normal screen appears.

- Repeat steps 1 – 9 for each additional programme.

10

## ENGAGE RECORDER'S TIMER MODE

Press **⏸ (TIMER)**. The recorder turns off automatically and **⏸** appears on the display panel.

- To disengage the timer, press **⏸ (TIMER)** again.

To Timer-Record Weekly Or Daily Serials . . .

. . . anytime during steps 2 through 9, press **WEEKLY (NUMBER key "9")** for weekly serials or **DAILY (NUMBER key "8")** for daily serials (Monday – Friday). Either "WEEKLY" or "DAILY" appears on the screen. Pressing the button again makes the corresponding indication disappear.

### NOTE:

You can programme this recorder to timer-record as many as 8 programmes. If you try to programme the recorder to record a ninth, "PROGRAM FULL" appears on screen and "FULL" appears on the front display panel. To record the extra programme, you must first cancel any unnecessary programmes (☞ pg. 16).

### Satellite Receiver Users

To timer-record a satellite broadcast using Express Timer Programming:

- 1 Perform steps 1 – 10. Enter "L-2" for the preset position in step 6.
- 2 Set the satellite receiver to the appropriate channel before the selected programme begins.
- 3 Leave the satellite receiver's power on.

## PDC Recording

Now available from some TV stations, PDC (Programme Delivery Control) is a service designed to assure safe, accurate timer recording. With this system, special code signals are transmitted together with the audio/video signals. These code signals control your video recorder and have precedence over the advertised times which you may have preset into the timer. This means that your recorder will start and stop recording when the preset TV programmes actually start and end — even if the broadcast time of a preset TV programme is changed from what has been advertised. PDC is currently available nationally on BBC1, BBC2, Ch.4 and Ch.5, except from a few small relay transmitters. Ch.3 operates a PDC service only in a very few areas. All channels intend to offer this service in due course. Check your TV programme listing guide for latest information. If the channel you intend to record does not offer a PDC service your recorder will not start recording if PDC has been selected. Be sure to set PDC to "OFF" if PDC is not available on your selected channel. (☞ step 8 in the left column).

### NOTES:

- Set the start time (PDC time) exactly as advertised in the TV listing. A different time than advertised will result in no recording.
- PDC recording is also possible when a satellite receiver or a cable system is connected to AV2 IN/DECODER on your recorder.
- PDC recording is also possible via the AV1 IN/OUT connector and the front panel connectors.

## Timer Warning

If you have programmed your recorder to timer-record a programme or a series of programmes, a warning appears on the screen to tell you that the recording is due to start in 5 minutes.

– WARNING –  
TIMER RECORDING  
TO START SOON  
⏸ [X]

### NOTES:

- The warning only appears if you're not in the Timer mode at the time.
- If this recorder is being used as the player for tape dubbing, the warning screen will be recorded on the tape in the other video recorder.

The warning blinks for the entire 5 minutes leading up to the start of timer recording. To clear the display, press **X**.



## Check, Cancel And Replace Programmes

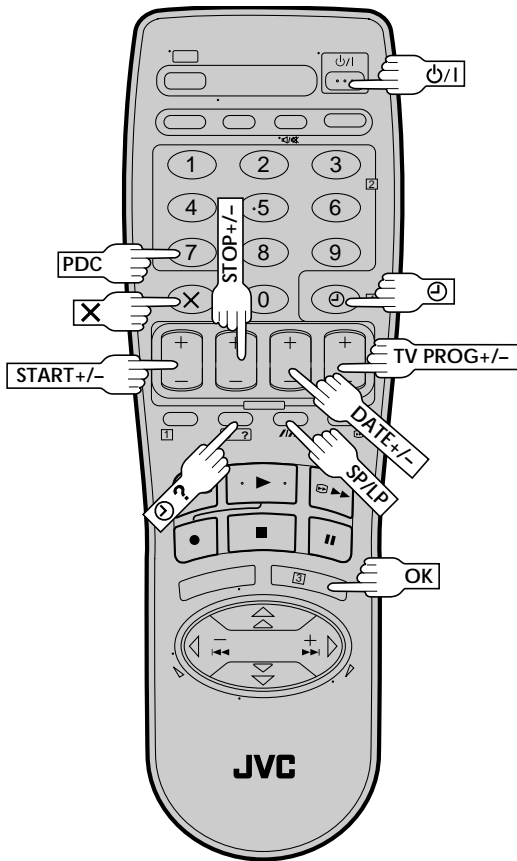

### 1 DISENGAGE TIMER MODE

Press , then press .

### 2 ACCESS PROGRAMME CHECK SCREEN/DISPLAY



Press  ?.

PR	START	STOP	CH	DATE
1	8:00	10:00	3	24.12
2	10:00	10:45	2	25.12
3	11:30	13:00	1	25.12
4				
5				
6				
7				
8				

[ ?] : NEXT



### 3 ACCESS PROGRAMME SCREEN/DISPLAY

Press  ? again to check more information. Each time you press  ?, the next programme's information appears.

- P1 -	
START 8:00	STOP 10:00
SP	VPS/PDC OFF
DATE 24.12	TV PROG 3 ITV

[ ?] : NEXT



- The display panel shows the programme start time. Pressing **OK** changes the display to the programme stop time, then the date and the preset position.

## To cancel or replace a programme...

### 4 CANCEL OR REPLACE A PROGRAMME

Press **X** to cancel a programme. To replace a programme, press the appropriate button: **START+/-**, **STOP+/-**, **DATE+/-**, **TV PROG+/-**, **SP/LP (///)**, **PDC**.

### 5 RETURN TO NORMAL SCREEN/DISPLAY

Press  ? as many times as necessary. If there are still some programmes to be recorded, go on to step 6.

### 6 RETURN TO TIMER MODE

Press .

## NOTE:

You can also check the programmes on the display panel even when the recorder's power is off or the recorder is in the Timer mode. However, it is not possible to cancel or replace the programmes.

# Playback Picture Adjustment

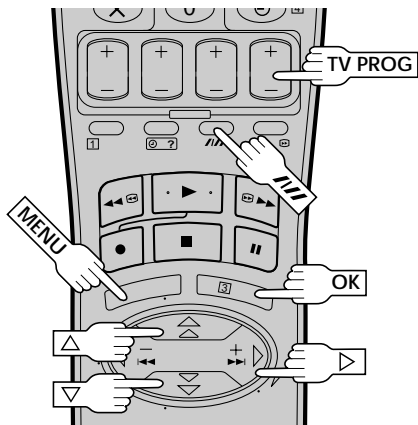

## Manual Tracking

Your video recorder is equipped with automatic tracking control. For most tapes this will automatically adjust the tracking to suit the particular tape you are playing. In some circumstances it may be necessary to make manual tracking adjustments. This is usually only associated with old or worn tapes or recordings made on old or worn recorders. If the automatic tracking control fails to operate correctly you will see noise bars across the picture as shown on the left below. To correct this you can override the automatic control and adjust the tracking manually by pressing the **TV PROG** buttons.

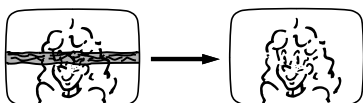

- 1** **OVERRIDE AUTOMATIC TRACKING**  
Press **///** on the remote to engage manual tracking.
- 2** **ADJUST TRACKING MANUALLY**  
Press **TV PROG** + or - to adjust tracking.
- 3** **RETURN TO AUTOMATIC TRACKING**  
Press **///** on the remote to re-engage automatic tracking.

### NOTE:

When a new tape is inserted, the recorder returns to the automatic tracking mode automatically.

## Picture Control

This feature helps you to adjust the playback picture quality according to your preference. \*The default setting is "AUTO."

- 1** **ACCESS MAIN MENU SCREEN**  
Press **MENU**.
  - 2** **ACCESS MODE SET SCREEN**  
Move the highlighted bar (pointer) to "MODE SET" by pressing  $\Delta \nabla$ , then press **OK** or  $\triangleright$ .
  - 3** **SELECT PICTURE CONTROL SET MODE**  
Move the highlighted bar (pointer) to "PICTURE CONTROL" by pressing  $\Delta \nabla$ , then press **OK** or  $\triangleright$  to select the desired mode.  
**AUTO:** Provides optimised picture benefits of B.E.S.T. Picture System. Normally select **AUTO**.  
**EDIT:** Minimizes picture degradation during editing (recording and playback).  
**SOFT:** Reduces image coarseness when viewing overplayed tapes containing a lot of noise.  
**SHARP:** Clearer, sharper-edged picture when viewing images with lots of flat, same-coloured surfaces such as cartoons.
- | MODE SET               |             |
|------------------------|-------------|
| B. E. S. T.            | ON          |
| <b>PICTURE CONTROL</b> | <b>AUTO</b> |
| AUTO TIMER             | OFF         |
| O. S. D.               | ON          |
| AUTO SP→LP TIMER       | OFF         |
- [ $\Delta \nabla$ ] → [OK]  
[MENU] : EXIT
- NOTES:**
- When you select **EDIT**, **SHARP** or **SOFT**, the selected mode will not change until you select again.
  - When you select **EDIT** to dub tapes, be sure to select **AUTO** after you finish dubbing the tapes.
- 4** **RETURN TO NORMAL SCREEN**  
Press **MENU**.
- NOTES:**
- When **B.E.S.T.** is **OFF**, "PICTURE CONTROL" switches automatically from **AUTO** to **NORM**.
  - Select **EDIT** when you are dubbing tapes. Refer to page 24.

# Playback/ Recording According To Tape Charac- teristics

Turn on the TV and select the VIDEO channel (or AV mode).

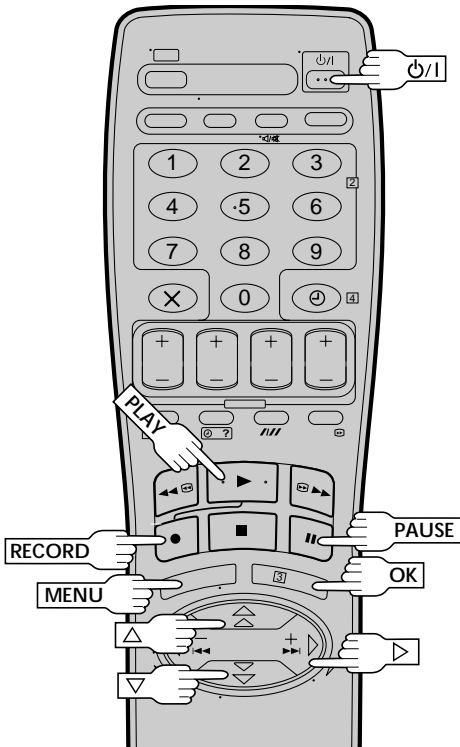
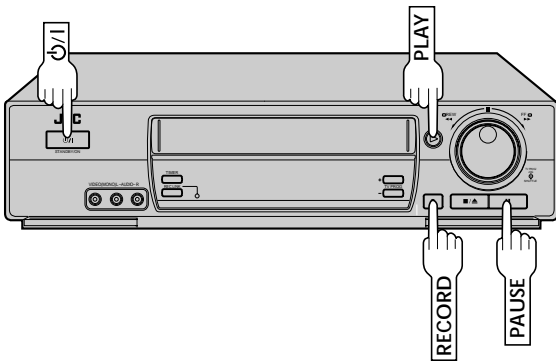

## B.E.S.T. Picture System

The B.E.S.T. (Biconditional Equalised Signal Tracking) system checks the condition of the tape in use during recording and playback, and compensates to provide the highest-possible recording and playback pictures. The default setting for both recording and playback is "ON".

### 1 TURN ON THE RECORDER

Press  $\text{P}/\text{I}$ .

### 2 ACCESS MAIN MENU SCREEN

Press MENU.

### 3 ACCESS MODE SET SCREEN

Press  $\Delta/\nabla$  to move the highlight bar (pointer) to "MODE SET", then press OK or  $\triangleright$ .

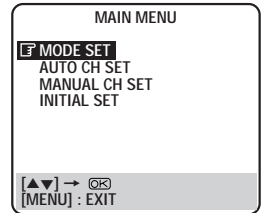

### 4 SELECT B.E.S.T. MODE

Press  $\Delta/\nabla$  to move the highlight bar (pointer) to "B.E.S.T.", then press OK or  $\triangleright$  to set to "ON" or "OFF".

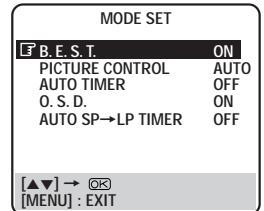

### 5 RETURN TO NORMAL SCREEN

Press MENU.

## Recording

1

### START RECORDING

Press and hold **RECORD** and press **PLAY** on the remote, or press **RECORD** on the recorder.

**DURING B.E.S.T.**



**B.E.S.T. COMPLETE**



- The recorder spends approximately 7 seconds assessing the condition of the tape, then begins recording.

### NOTES:

- The B.E.S.T. system works for both SP and LP modes only after a tape has been inserted and the Record mode is first initiated. It does not work during recording.
- The B.E.S.T. system does not work while Auto Satellite Prog recording is in progress (⇨ pg. 22).
- In the case of timer recording, the B.E.S.T. system works before recording is initiated.
- Once the cassette is ejected, the B.E.S.T. data is cancelled. The next time the cassette is used for recording, B.E.S.T. is re-performed.
- Pressing the recorder's **RECORD** button while "BEST" is displayed does not start Instant Timer Recording (⇨ pg. 11).

### ATTENTION

*Since the B.E.S.T. system works before recording actually starts, there is a delay of approximately 7 seconds after **RECORD** and **PLAY** on the remote are pressed, or **RECORD** on the recorder is pressed. To make sure you record the desired scene or programme in its entirety, first perform the following steps:*

- 1) Press and hold **PAUSE** and press **RECORD** to engage the **RECORD PAUSE** mode.
  - The recorder then automatically checks the condition of the tape and, after approximately 7 seconds, re-enters **RECORD PAUSE**.
- 2) Press **PLAY** when you are ready to start recording.
  - If you want to bypass the B.E.S.T. system and begin recording immediately, set "B.E.S.T." to "OFF" in step 4 on page 18.

## Playback

The recorder assesses the quality of the tape once you initiate playback.

1

### START PLAYBACK

Press **PLAY**.

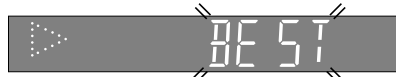

- The recorder adjusts the playback picture quality based on the quality of the tape in use.
- B.E.S.T. is active during Auto Tracking. "BEST" appears blinking on the recorder's display panel.

### NOTES:

- When watching a tape recorded with "B.E.S.T." set to "ON", it is recommended that you leave B.E.S.T. on during playback as well.
- When watching a rental tape or one recorded on another video recorder, or when using this recorder as the player for editing, set B.E.S.T. to your preference by performing steps 1 through 5 on page 18.
- "BEST" only appears at the beginning of automatic tracking. Even though it doesn't appear after that, the B.E.S.T. function is operative.

# Selecting The Sound You Want



## Receiving NICAM Stereo And Bilingual Programmes

Your recorder is equipped with a Digital stereo sound decoder (NICAM), making reception of stereo and bilingual broadcasts possible.

When the recorder is tuned to a different station, the type of broadcast being received will be displayed on the TV screen for a few seconds.

Type of Broadcast Being Received	On-screen Display
Regular Monaural	(none)
NICAM Stereo	ST NICAM
NICAM Bilingual	BIL NICAM
NICAM Monaural	NICAM

- To listen to a stereo programme, press **AUDIO** until "HI FI L [L] R" appears on the screen.
- To listen to a bilingual programme, press **AUDIO** until "HI FI L [L] R" or "HI FI [L] R" appears on the screen (as required).
- To listen to the Standard (regular monaural) audio while receiving a NICAM broadcast, press **AUDIO** until "NORM" appears on the screen.

### NOTES:

- The NICAM audio programme will be recorded on the Hi-Fi audio track, and the Standard audio programme on the normal audio track.
- If the quality of stereo sound being received is poor, the broadcast will be received in monaural with better quality.
- Before playing back a programme recorded in stereo, or a bilingual programme, refer to "Soundtrack Selection" (See below).
- "O.S.D." must be set to "ON" or the on-screen displays will not appear (⇐ pg. 26).

## Soundtrack Selection

Your video recorder is capable of recording three soundtracks (HI-FI L, HI-FI R and NORM) and will play back the one you select.

### During Playback

Pressing **AUDIO** on the remote control changes the soundtrack being played back as follows:

TRACK	USE
On-Screen Display	
HI FI L [L] R	For Hi-Fi stereo tapes
HI FI L [L]	For main audio of Bilingual tapes
HI FI [L] R	For sub audio of Bilingual tapes
NORM	For audio-dubbed tapes
HI FI NORM	For audio-dubbed tapes

### NOTES:

- "HI FI L [L] R" should normally be selected. In this mode, Hi-Fi stereo tapes are played back in stereo, and the normal audio track is played back automatically for tapes with only normal audio.
- For instructions on recording NICAM stereo and bilingual programmes (See above).
- Bilingual programmes are not currently broadcast in the U.K.
- "O.S.D." must be set to "ON" or the on-screen displays will not appear (⇐ pg. 26).

# Looking For The Scene You Want

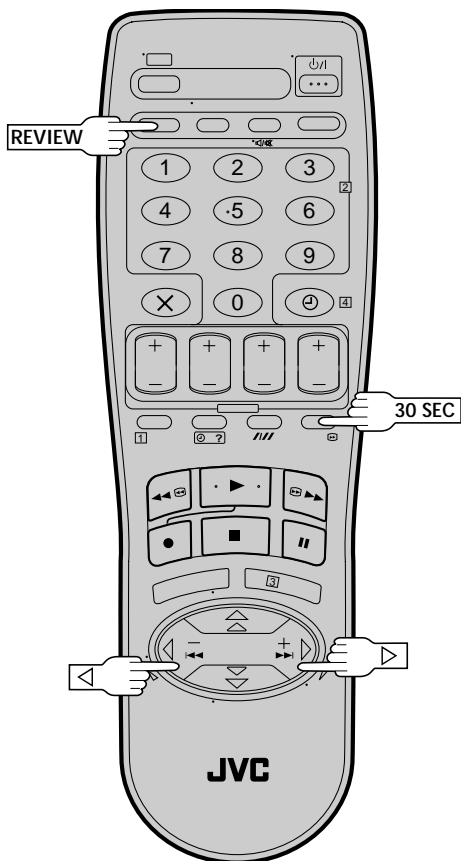

## Index Search

Your recorder automatically marks index codes at the beginning of each recording. This function gives you quick access to any one of 9 index codes in either direction.

### NOTE:

Before starting, make sure the recorder is in the Stop mode.



## 1 ACTIVATE INDEX SEARCH

Press < or > (◀◀ or ▶▶). "◀◀ 1" or "▶▶ 1" is displayed on screen and search begins in the corresponding direction.

- To access index codes 2 through 9, press < or > repeatedly until the correct index number is displayed.

Ex.: To locate the beginning of B from the current position, press < twice.

To locate the beginning of D from the current position, press > once.

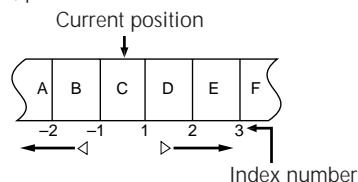

- When the specified index code is located, playback begins automatically.

## Instant ReView

Simply by pressing a single button, the recorder power comes on, rewinds, and begins playback of the last timer-recorded programme. If you have several programmes recorded, you can easily access any of them.

### NOTE:

Before starting, make sure that the recorder is off and that the Timer mode is disengaged.

## 1 ACTIVATE INSTANT REVIEW

Press **REVIEW**. The recorder power comes on and the recorder searches for the index code indicating the start of the last timer-recorded programme. Once it's found, playback begins automatically.

- The front display panel tells you how many programmes have been timer-recorded. If you have, for example, 3 programmes, "REVIEW" and "3" appear and blink. To watch the first of the 3 programmes, press **REVIEW** three times. The recorder searches and begins playback automatically. You can access a programme as far as 9 index codes away from the current tape position.

### NOTES:

- Instant ReView is not possible while the recorder is in the Timer mode.
- The number of recorded programmes will not be displayed on the front display panel after Auto Satellite Prog recording (see pg. 22).

## Skip Search

### 1 SKIP OVER UNWANTED SECTIONS

Press **30 SEC** 1 to 4 times during playback. Each press initiates a 30-second period of fast-motion playback. Normal playback resumes automatically.

### NOTE:

To return to normal playback during a Skip Search, press **PLAY**.

# Automatic Satellite Programme Recording

This facility allows you to record automatically a satellite programme which is timer-programmed on your external satellite receiver. Connect a satellite receiver to the recorder's AV2 IN/DECODER connector and programme the timer on the satellite receiver; the recorder starts recording when the signals input from the satellite receiver to the AV2 IN/DECODER connector, and when there is no input signals the recorder stops recording and the power shuts off.

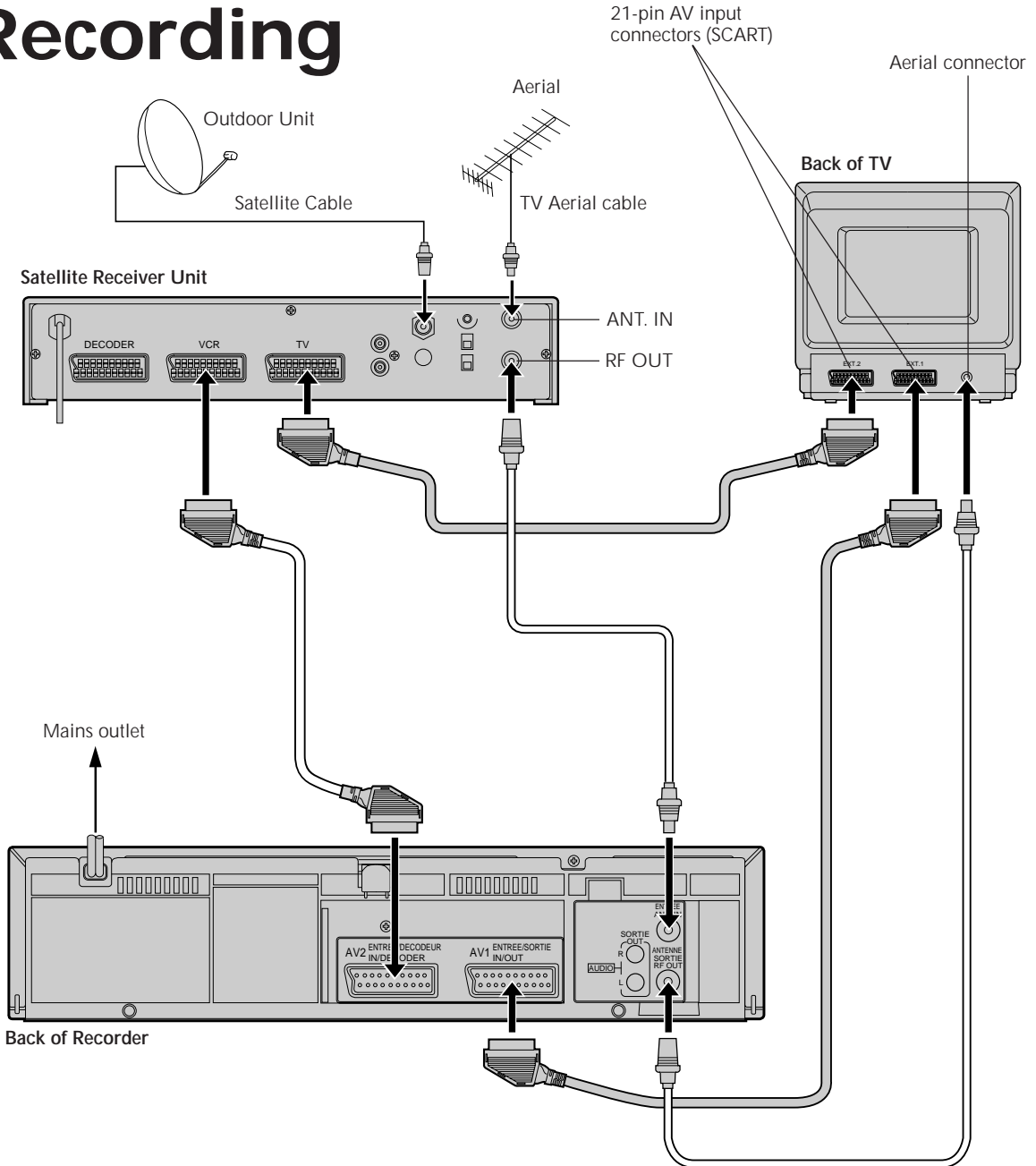

## NOTES:

- When connecting your recorder to a TV equipped with 21-pin AV input connectors (SCART), follow the illustration above using the cables shown in grey.
- For details, check your satellite receiver's instruction manual.



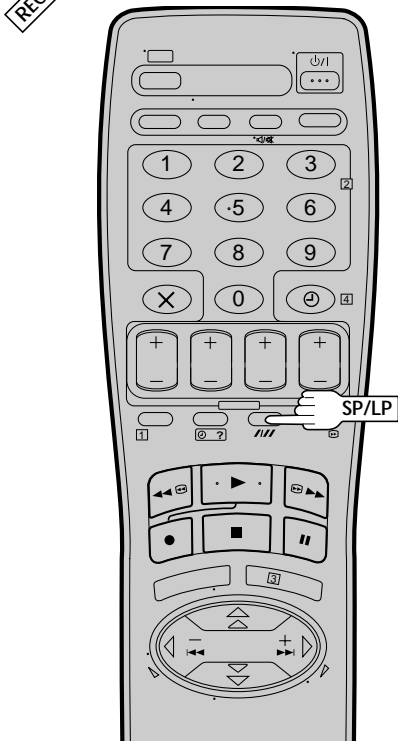

#### Before performing the following steps:

- Make sure the satellite receiver is connected to the recorder's AV2 IN/DECODER connector. (☞ pg. 22)
- Programme the timer on the satellite receiver.
- Insert a cassette with the safety tab in place.

## 1 SET TAPE SPEED

Press **SP/LP** (//) on the remote control to set the tape speed.

## 2 ENGAGE AUTO SATELLITE PROG REC MODE

Press and hold **REC LINK** for about 2 seconds. The indicator lights up and the recorder turns off automatically.

- To disengage the Auto Satellite Prog Rec mode, press **REC LINK**. The indicator goes off.
- If the recorder's power is off, it is not possible to engage the Auto Satellite Prog Rec mode.

### ATTENTION

- Be sure not to turn on the satellite receiver before the programme is executed; otherwise, the recorder will start recording when the satellite receiver's power is turned on.
  - If you have connected another appliance other than a satellite receiver to the AV2 IN/DECODER connector, be sure not to engage the Auto Satellite Prog Rec mode; otherwise, the recorder will start recording when the connected appliance's power is turned on.
  - Auto Satellite Prog recording and timer-recording cannot be done at the same time.
  - When you press and hold the recorder's **REC LINK** button to engage the Auto Satellite Prog Rec mode, if the REC LINK indicator does not light but instead blinks quickly even though your satellite receiver's power is off, Auto Satellite Prog Recording will not work properly with that satellite receiver\*. If this is the case, perform "Express Timer Programming" (☞ pg. 14) to timer-record a satellite programme.
- \* Some satellite receivers output signals even if the power is off. Auto Satellite Prog Recording is not possible with those satellite receivers.

### NOTES:

- Auto Satellite Prog recording is possible with the AV2 IN/DECODER connector only.
- When the Auto Satellite Prog Rec mode is engaged or the recorder's power is turned off after Auto Satellite Prog recording is finished, the recorder will not enter the Timer mode even though "AUTO TIMER" is set to "ON".
- After Auto Satellite Prog recording, the number of recorded programmes will not be displayed on the front display panel for the Instant ReView function (☞ pg. 21).
- For timer programming of the satellite receiver, refer to the instruction manual of the satellite receiver.
- Auto Satellite Prog recording is not possible if your satellite receiver does not have a timer.
- The REC LINK indicator blinks while Auto Satellite Prog recording is in progress.
- Pressing the recorder's  $\psi/1$  button while Auto Satellite Prog recording is in progress turns off the recorder's power and disengages the Auto Satellite Prog Rec mode.
- If there is more than one satellite programme you wish to record with Auto Satellite Prog Recording, it is not possible to set a different tape speed for each; the tape speed selected in step 1 will apply to all the programmes for Auto Satellite Prog recording.
- The B.E.S.T. system (☞ pg. 18) does not work while Auto Satellite Prog recording is in progress.
- Just Clock (☞ pg. 39) does not work when the Auto Satellite Prog Rec mode is engaged.
- Depending on the type of satellite receiver, the recorder may not record a short portion at the beginning of the programme or may record slightly longer than the actual length of the programme.
- If you engage the Auto Satellite Prog Rec mode when the satellite receiver's power is on, the recorder will not start Auto Satellite Prog recording even though the REC LINK indicator blinks. When the satellite receiver shuts off once and is turned back on again, the recorder starts recording.
- You can also record a programme from your cable system in the same way if the system has a timer and is connected to the recorder's AV2 IN/DECODER connector.

# Edit To Or From Another Video Recorder

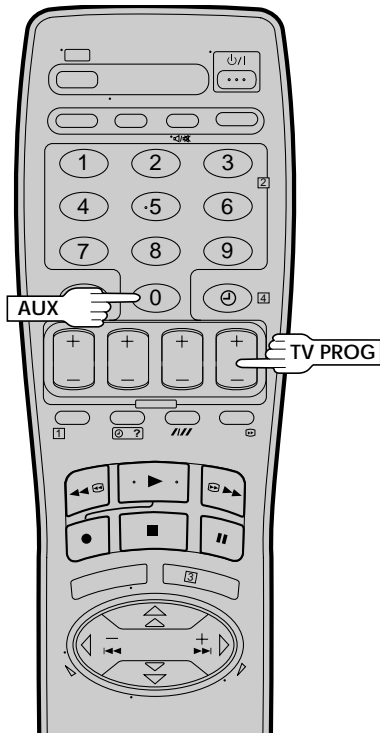

You can use your video recorder as the source player or as the recording deck.

## 1 MAKE CONNECTIONS

Connect the player's 21-pin SCART connector to the recorder's 21-pin SCART connector as illustrated on the below.

*When Using Your Video Recorder As The Source Player . . .*

. . . connect its AV1 IN/OUT connector to the recording deck.

*When Using Your Video Recorder As The Recording Deck . . .*

. . . connect its AV2 IN/DECODER or AV1 IN/OUT connector to the source player.

## 2 SET RECORDING DECK'S INPUT MODE

Set to AUX. With this video recorder, press **AUX** and/or **TV PROG** to select "L-1" for the AV1 IN/OUT connector, or "L-2" for the AV2 IN/DECODER connector, depending on the connector being used.

## 3 SET EDIT MODE

See "Picture Control" on page 17.

## 4 START SOURCE PLAYER

Engage its Play mode.

## 5 START RECORDING DECK

Engage its Record mode.

### NOTES:

- All necessary cables can be obtained from your dealer.
- When you select **EDIT** to dub tapes in step 3, be sure to select **AUTO** (or **NORM** when **B.E.S.T.** is set to **OFF**) after you finish dubbing the tapes.
- When you use this recorder as the player for editing, be sure to set "O.S.D." to "OFF" before starting (⇐ pg. 26).

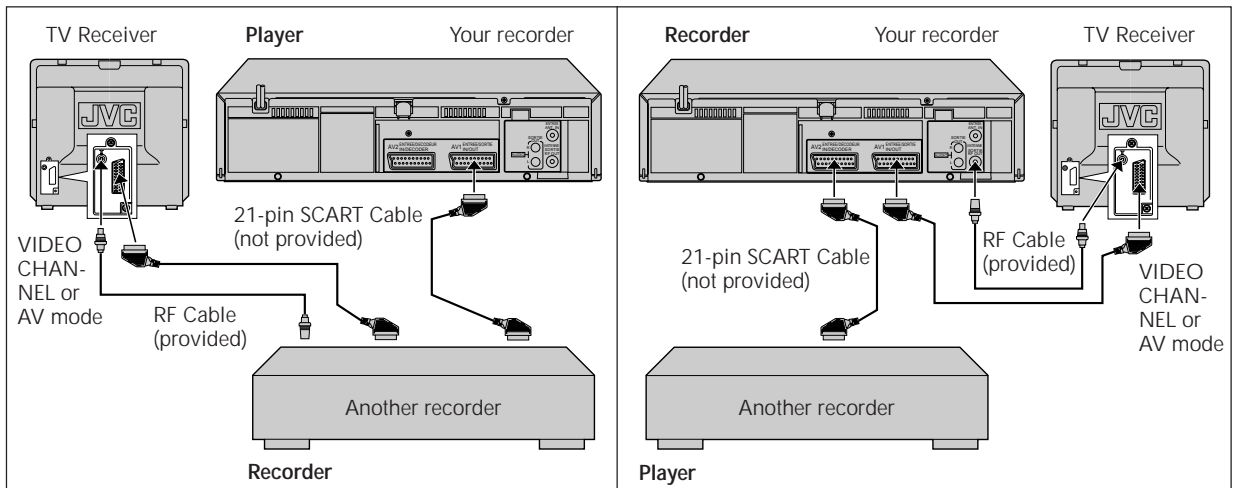

# Edit From A Camcorder

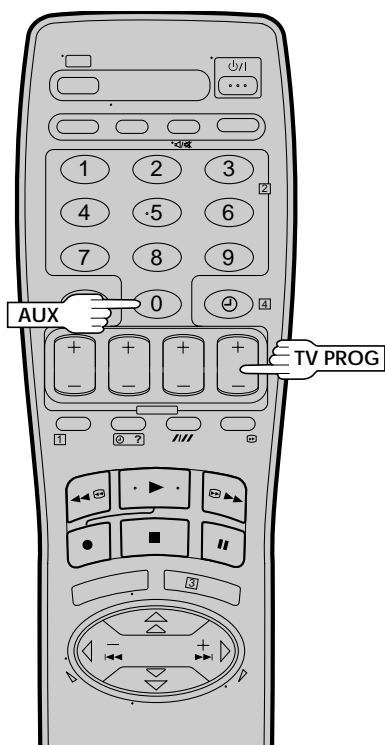

You can use a camcorder as the source player and your video recorder as the recorder.

## 1 MAKE CONNECTIONS

Connect the camcorder's AUDIO/VIDEO OUT connectors to the recorder's front panel AUDIO/VIDEO input connectors.

- When using a monaural camcorder, connect its AUDIO OUT connector to the AUDIO L input connector on your recorder.

## 2 SET RECORDER'S INPUT MODE

Press **AUX** and/or **TV PROG** so that "F-1" appears in place of a preset position number.

## 3 SET EDIT MODE

See "Picture Control" on page 17.

## 4 START CAMCORDER

Engage its Play mode.

## 5 START RECORDER

Engage its Record mode.

### NOTES:

- All necessary cables can be obtained from your dealer.
- When you select **EDIT** to dub tapes in step 3, be sure to select **AUTO** (or **NORM** when **B.E.S.T.** is set to **OFF**) after you finish dubbing the tapes.

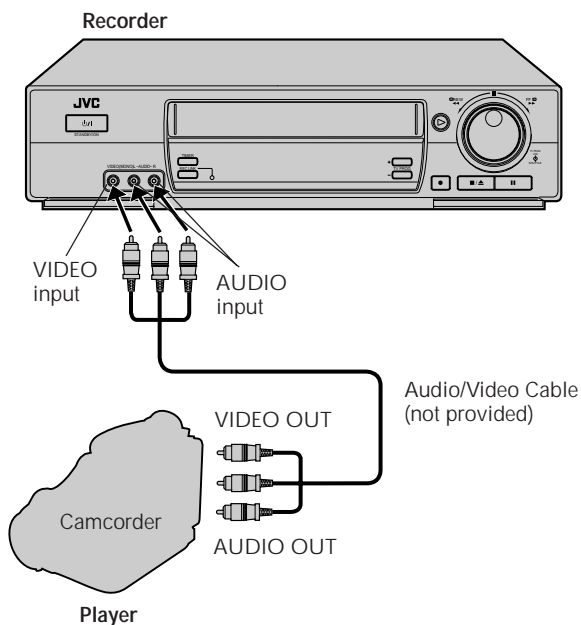

# Other Functions

Turn on the TV and select the VIDEO channel (or AV mode).

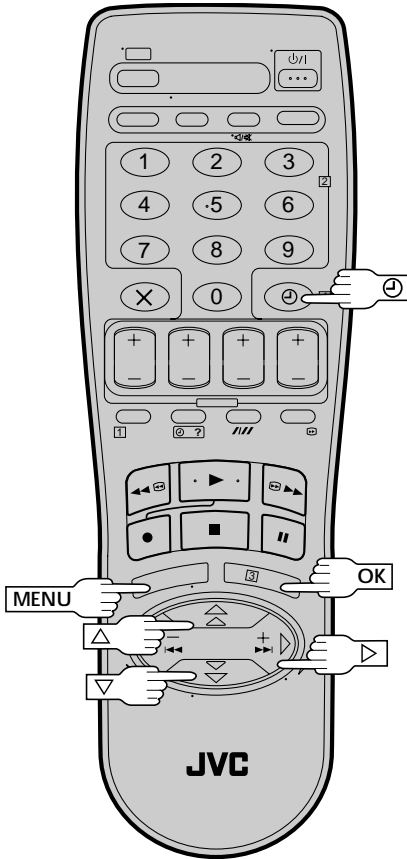

## On-Screen Display

You can choose whether or not to have various operational indicators appear on screen, by setting this function ON or OFF.

### 1 ACCESS MAIN MENU SCREEN

Press MENU.

### 2 ACCESS MODE SET SCREEN

Move the highlight bar (pointer) to "MODE SET" by pressing  $\Delta \nabla$ , then press OK or  $\triangleright$ .

### 3 ENABLE/DISABLE ON-SCREEN DISPLAY

The default setting is "ON", so if you want on-screen displays, leave the setting as it is and go to step 4. If you don't want the displays to appear, press  $\Delta \nabla$  to move the highlight bar (pointer) to "O.S.D." and press OK or  $\triangleright$  to set "O.S.D." to "OFF".

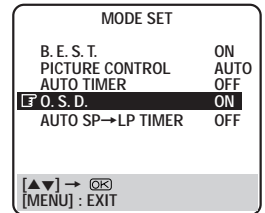

### 4 RETURN TO NORMAL

Press MENU.

## NOTES:

- When you use this recorder as the player for editing, be sure to set "O.S.D." to "OFF" before starting.
- During playback, the operation mode indicators may sometimes be disturbed depending on the type of tape being used.

The superimposed indication on the TV screen tells you what the recorder is doing.

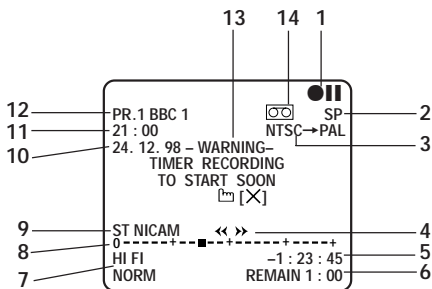

- 1- Operation mode indicators
- 2- Tape speed SP/LP/EP (EP is for NTSC playback only)
- 3- NTSC playback display (☞ pg. 28)
- 4- Tape direction
- 5- Counter display
- 6- Tape remaining time indicator (☞ pg. 11)
- 7- Audio mode display (☞ pg. 20)
- 8- Tape position indicator (☞ pg. 8)
- 9- NICAM display (☞ pg. 20)
- 10- Current day/month/year
- 11- Clock display
- 12- Preset position number and station name/Aux. indicator (L-1, L-2 or F-1)
- 13- Timer warning display (☞ pg. 13, 15)
- 14- Cassette loaded mark

## Auto SP→LP Timer

If, when timer-recording in SP mode, there is not enough tape to record the entire programme, the recorder automatically switches to LP mode to allow complete recording.

**For Example . . .**

Recording a programme of 210 minutes in length onto a 180-minute tape

Approximately 150 minutes                      Approximately 60 minutes

SP mode	LP mode
Total 210 minutes	

Make sure you set "AUTO SP→LP TIMER" to "ON" at the Mode Set screen before the timer-recording starts.

### 1 ACCESS MAIN MENU SCREEN

Press **MENU**.

### 2 ACCESS MODE SET SCREEN

Press  $\Delta\nabla$  to move the highlight bar (pointer) to "MODE SET", then press **OK** or  $\triangleright$ .

### 3 SELECT MODE

Press  $\Delta\nabla$  to move the highlight bar (pointer) to "AUTO SP→LP TIMER", then press **OK** or  $\triangleright$  to select "ON".

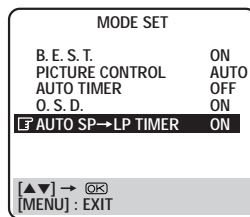

### 4 RETURN TO NORMAL SCREEN

Press **MENU**.

## Auto Timer

When the Auto Timer is set to ON the timer is automatically engaged when the recorder power is turned off and automatically disengaged when the recorder is powered back on.

### 1 ACCESS MAIN MENU SCREEN

Press **MENU**.

### 2 ACCESS MODE SET SCREEN

Press  $\Delta\nabla$  to move the highlight bar (pointer) to "MODE SET", then press **OK** or  $\triangleright$ .

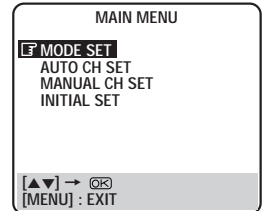

### 3 SELECT MODE

Press **OK** or  $\triangleright$  to select either "ON" or "OFF".

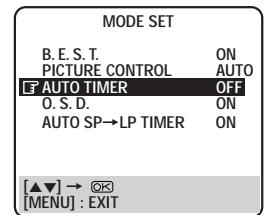

### 4 RETURN TO NORMAL SCREEN

Press **MENU**.

### NOTE:

For safety, when Auto timer is set to "OFF", all other recorder functions are disabled while the Timer mode is engaged. To disengage the timer, press  $\odot$  (TIMER).

### NOTES:

- The Auto SP→LP Timer feature is not available during ITR (Instant Timer Recording), and the feature will not work properly with any tapes longer than E-180 or with some tapes of shorter lengths.
- If you have programmed the recorder to timer-record 2 or more programmes, the second programme and those thereafter may not fit on the tape if you set "AUTO SP→LP TIMER" to "ON". In this case, make sure the mode is not engaged, then set the tape speed manually during timer programming.
- In order to ensure that the recording fits on the tape, this feature may leave a short non-recorded section at the end of the tape.
- There may be some picture noise and sound disturbance at the point on the tape where the recorder switches from SP to LP mode.
- If you perform timer recording with both PDC and the Auto SP→LP Timer activated, and the programme goes beyond its originally scheduled length, there may be times when the programme cannot be recorded in its entirety.

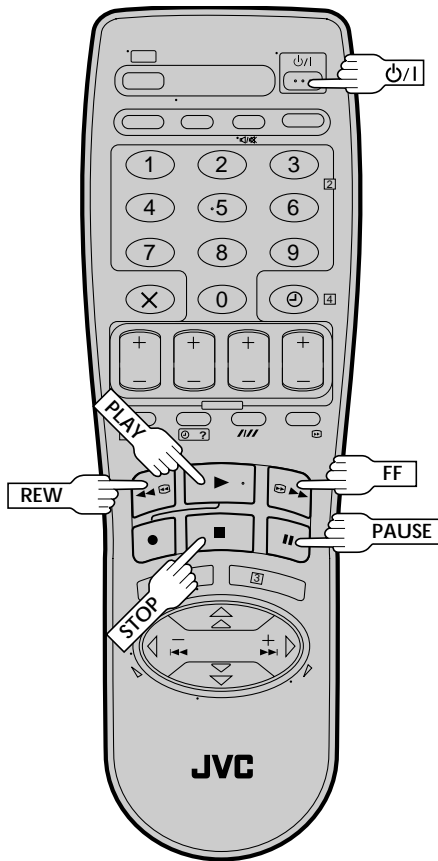

## Next Function Memory

The Next Function Memory "tells" the recorder what to do after rewinding. Before continuing, make sure the recorder is in the Stop mode.

- a- For Automatic Start Of Playback After Tape Rewind . . .  
... press **REW**, then press **PLAY** within 2 seconds.
- b- For Automatic Power Off After Tape Rewind . . .  
... press **REW**, then press **⏻** within 2 seconds.
- c- For Automatic Timer Standby After Tape Rewind . . .  
... press **REW**, then press **⏻** (TIMER) within 2 seconds.

## Repeat Playback

Your video recorder can automatically play back the whole tape 50 times repeatedly.



### 1 START PLAYBACK

Press **PLAY**.

### 2 ACTIVATE REPEAT PLAYBACK

Press **PLAY** and hold for over 5 seconds, then release.

- The Play indicator (⏻) on the display panel blinks slowly.
- The tape plays 50 times automatically, and then stops.

### 3 STOP PLAYBACK

Press **STOP** at any time to stop playback.

#### NOTE:

Pressing **PLAY**, **REW**, **FF** or **PAUSE** also stops Repeat Playback.

## NTSC Playback

Your video recorder is equipped with NTSC circuitry that can play back NTSC tapes.

### 1 LOAD A CASSETTE

Insert a cassette recorded in NTSC.

### 2 START PLAYBACK

Press **PLAY**.

- "NTSC→PAL" appears on the screen for about 5 seconds.
- Some TVs shrink the picture vertically and place black bars at the top and bottom of the screen. This is not a malfunction on the part of either the video recorder or the TV.
- The picture may roll up and down. This can be corrected using the V-HOLD control found on some TVs. (This cannot be corrected if the TV does not have a V-HOLD control.)
- The counter and tape remaining time readings will be incorrect.
- During search, still, or frame-by-frame playback, the picture will be distorted, and there may be a loss of colour.
- Depending on the type of TV, the top and bottom portions of superimposed displays may be cut off during NTSC playback.

# Connection To A Stereo System

These instructions enable you to connect your video recorder to your Hi-Fi stereo system (if you have one) and listen to the soundtrack through the stereo.

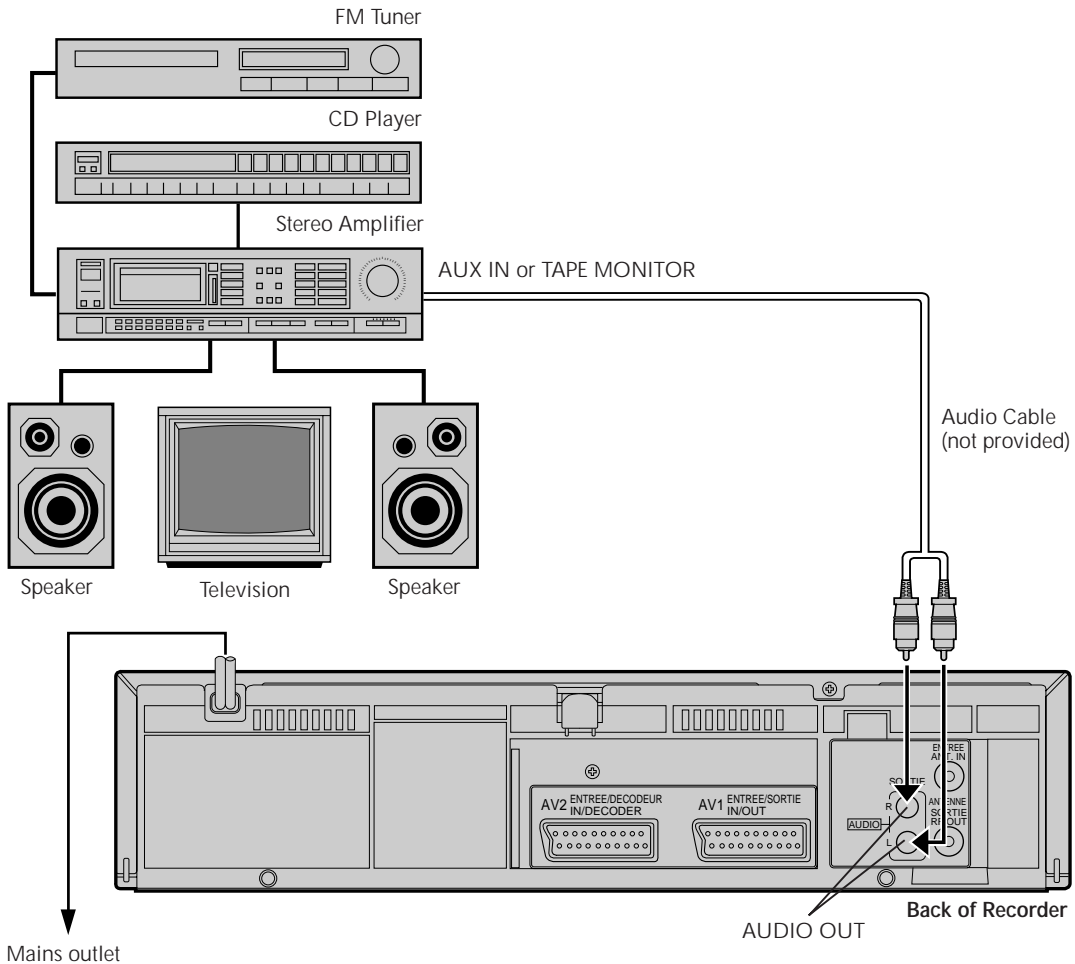

## 1 MAKE CONNECTIONS

Connect the AUDIO OUT L and R connectors on your video recorder to the AUX IN or TAPE MONITOR terminals on your stereo system's receiver or amplifier.

### NOTES:

- When connecting your recorder's audio output connectors to a stereo amplifier, make sure you connect L and R correctly.
- If you can receive NICAM TV broadcasts in your area, this recorder can record them independently of the TV set and play them back through the connected stereo system.
- When listening to sound through the connected stereo system, turn the TV's volume down completely.

### CAUTIONS:

- This recorder has a dynamic range of more than 80 dB with regards to its Hi-Fi audio capability. It is recommended that you check the maximum level if you are going to listen to the Hi-Fi audio signals through a stereo amplifier. A sudden surge in the input level to the speakers may damage them.
- Some speakers and televisions are specially shielded to prevent television interference. If both are of the non-shielded type, do not place the speakers adjacent to the TV set as this can adversely affect the video playback picture.



# Video Channel Set

Video Channel (RF Output Channel) is the channel on which your TV receives picture and sound signals from the video recorder through the RF cable.

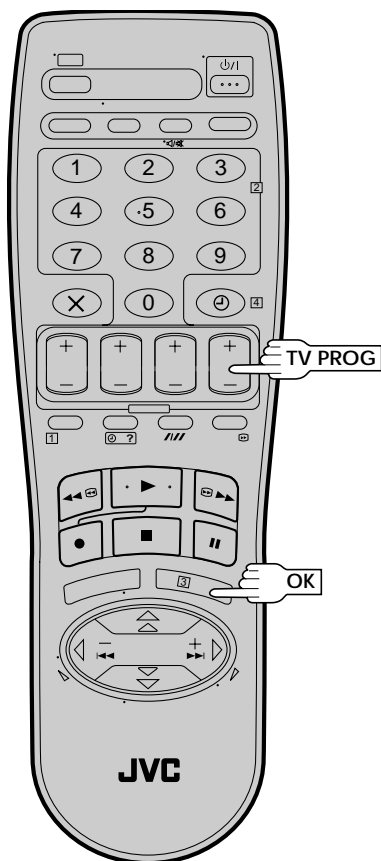
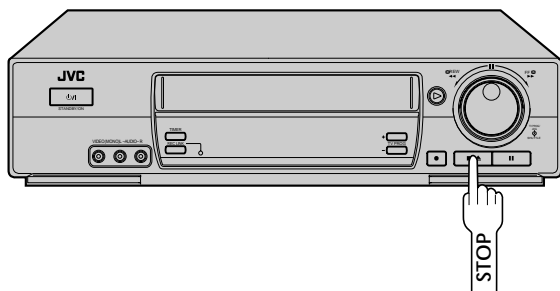

## IMPORTANT

- Perform the following steps only if —
- Video Channel Set has not been done correctly by the Auto Set Up function (⇨ pg. 6).
  - interference appears in the TV picture after you have moved to a different area or a new station has started broadcasting in your area.
  - you change the connection between your recorder and TV from RF connection to AV connection, or vice versa.

- *If you have connected the video recorder to your TV via both an RF cable and a 21-pin SCART cable (AV connection), you do not need the video channel so you have to set the video channel to off. — Go to "With AV Connection" below.*
- *If you have connected the video recorder to your TV via an RF cable only (RF connection), you have to set the correct video channel — Go to "With RF Connection" on page 31.*

## With AV Connection

Before performing the following procedure, make sure that:

- the mains power cord is plugged into the mains outlet.
- the video recorder is turned off and there is no cassette inserted in the recorder.
- batteries have been installed in the remote control.

## ACCESS VIDEO CHANNEL SET MODE

1

Press and hold down **STOP** on the recorder until the display panel shows the following.



## SET VIDEO CHANNEL

2

Press **TV PROG** — until the display panel shows "\_OUT--".



- Now the video channel is set to off.

## EXIT VIDEO CHANNEL SET MODE

3

Press **OK**.

To view picture signals from the video recorder, set your TV to its AV mode. Refer to the instructions supplied with your TV set for how to do this.

## With RF Connection

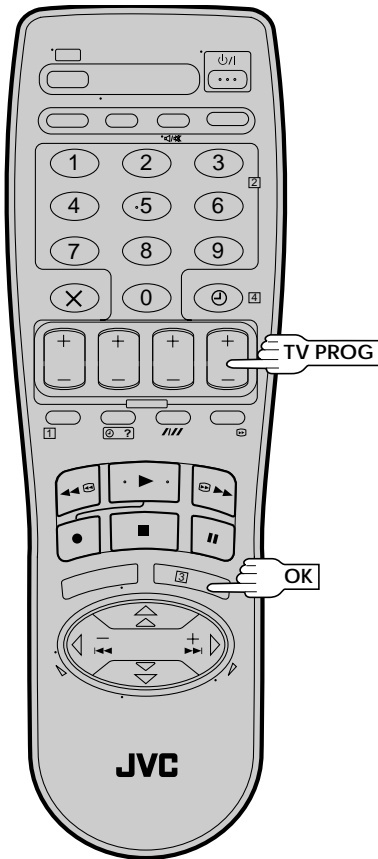
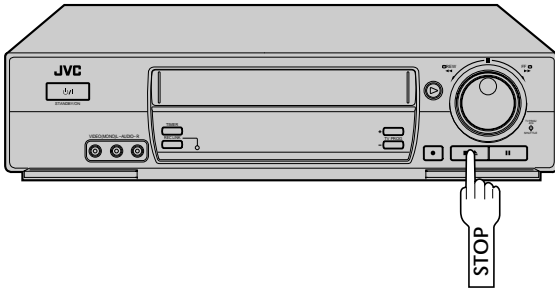

### TEST SIGNAL

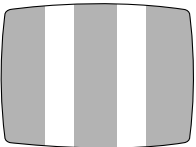

The channel on which the screen on the left appears clearly in step 2 is your Video Channel.

Before performing the following procedure, make sure that:

- the mains power cord is plugged into the mains outlet.
- the video recorder is turned off and there is no cassette inserted in the recorder.
- the connected TV is turned on.
- batteries have been installed in the remote control.

## ACCESS VIDEO CHANNEL SET MODE

**1** Press and hold down **STOP** on the recorder until the display panel shows the following.



## SET VIDEO CHANNEL

**2** Press **TV PROG+** or **-** to set the video recorder to a vacant channel between 22 and 69 which is not occupied by any local station in your area. Refer to list on page 42 for details of broadcast stations in your area.

(Ex.) If channel 36 is available in your area



Then set your TV to UHF channel 36. (Refer to the instructions supplied with your TV set for how to do this.)

- If the two vertical white bars appear clearly on the screen as shown in the illustration at bottom left, go to step 3.
- If the two vertical white bars do not appear clearly, re-set the video recorder to another vacant channel and try again.

### IMPORTANT

- If you set the video recorder to a channel which is occupied by a local station or has neighbouring channels that are occupied by local stations, the picture reception quality will be affected and some interference noise will appear on the TV screen. Be sure to select a vacant channel which has no broadcast on neighbouring channels.
- If you cannot obtain the two vertical white bars clearly with any channel between 22 and 69, consult your JVC dealer.

## EXIT VIDEO CHANNEL SET MODE

**3** Press **OK**.

To view picture signals from the video recorder, set your TV to the Video Channel.

# Tuner Set

Turn on the TV and select the VIDEO channel (or AV mode).

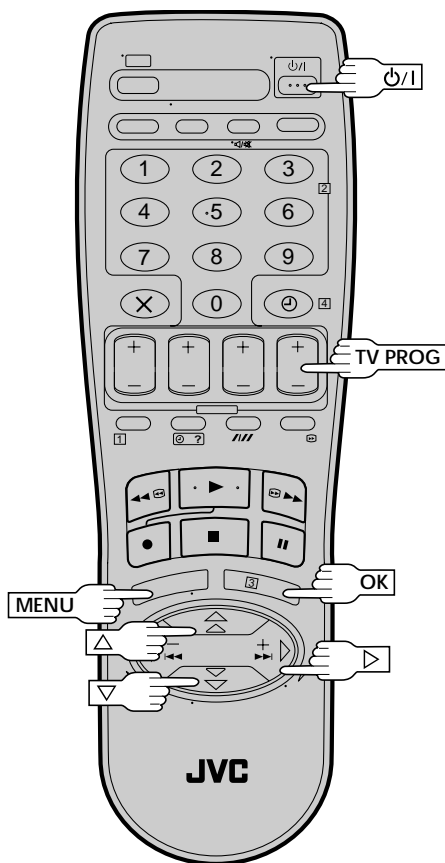

## IMPORTANT

Perform the following steps only if —

- Auto Channel Set has not been set correctly by Auto Set Up function (see pg. 6).
- you have moved to a different area or if a new station starts broadcasting in your area.

Your recorder needs to memorise all necessary stations in preset positions in order to record TV programmes. Auto Channel Set automatically assigns all receivable stations in your area to call them up by using the TV PROG buttons without going through any vacant channel.

## Auto Channel Set

### TURN ON THE RECORDER

# 1

Press P/I.

### ACCESS MAIN MENU SCREEN

# 2

Press MENU.

### PERFORM AUTO CHANNEL SET

# 3

Move the highlight bar (pointer) to "AUTO CH SET" by pressing  $\Delta$ / $\nabla$ , then press OK or  $\triangleright$ .

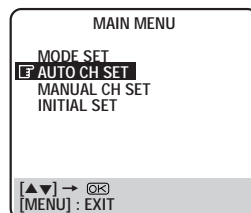

- The Auto Set screen appears, and remains on screen while the recorder searches for receivable stations. As Auto Channel Set progresses, the "■" mark on the screen moves from left to right.

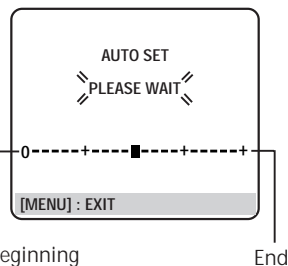

Wait until the screen as shown in step 4 appears.

- Auto Channel Set usually takes about 4 – 12 minutes; the duration varies by area.

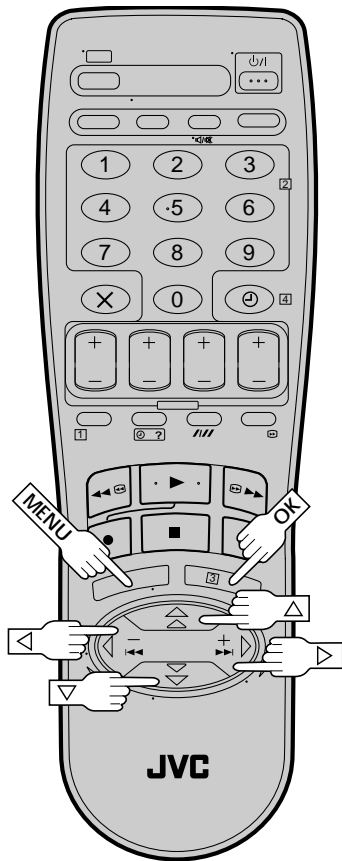

4

## VIEW CONFIRMATION SCREEN

After "SCAN COMPLETED" is displayed on the screen for about 5 seconds, a Confirmation screen looking like the one on the right appears. The stations your recorder located appear on a Confirmation screen — preset positions (PR), channels (CH) and station names (ID - see pg. 37). The blueback screen and the programme currently being broadcast by the station which is blinking appear alternately for 8 seconds each. To view the next page, use the  $\Delta \nabla \triangleleft \triangleright$  button on the remote control.

PR	CH	ID	PR	CH	ID
01	26	BBC1	08	----	----
02	33	BBC2	09	----	----
03	23	ITV	10	----	----
04	30	CH4	11	----	----
05	37	CH5	12	----	----
06	----	----	13	----	----
07	----	----	14	----	----

$\left[ \blacktriangle \blacktriangledown \blacktriangleleft \blacktriangleright \right]$   
 $\rightarrow$   $\left[ \text{EDIT} \right]$  : EDIT  
 $\rightarrow$   $\left[ \text{X} \right]$  : DELETE  
 $\left[ \text{MENU} \right]$  : EXIT

- The Guide Program numbers will also be set automatically during Auto Channel Set.

## RETURN TO NORMAL SCREEN

5

Press **MENU**.

- Using the Confirmation screen, you can skip or add preset positions, enter station names and perform other operations. Refer to pages 34 – 38 for the procedures.
- Depending on reception conditions, the stations may, on occasion, not be stored in order, and the station names may not be stored correctly.

## IMPORTANT

- In certain reception conditions, station names may not be stored correctly, and auto Guide Program Number Set may not work properly. If the Guide Program numbers are not set properly, when you timer-record a TV programme using VIDEO Plus+, the recorder will record a TV programme of a different station. When programming the timer using VIDEO Plus+, be sure to check that the preset position corresponding to the broadcasting station you wish to record has been selected (see pg. 12, "VIDEO Plus+ Timer Programming").
- Your video recorder memorizes all detected stations even if reception of some of them is poor. In these cases picture quality may be poor. To delete those stations which have an unacceptable picture see "Delete A Channel" on page 35.

## NOTES:

- Fine tuning is performed automatically during Auto Channel Set. If you wish to perform it manually, refer to page 35.
- If, for any reason, you perform Auto Channel Set when the aerial cable is not connected properly, "SCAN COMPLETED -NO SIGNAL-" appears on the screen in step 4. When this happens, make sure of the aerial connection and press **OK**; Auto Channel Set will take place again.

## Storing Channels Manually

To store channels that were not stored during Auto Set Up (☞ pg. 6) or Auto Channel Set (☞ pg. 32).

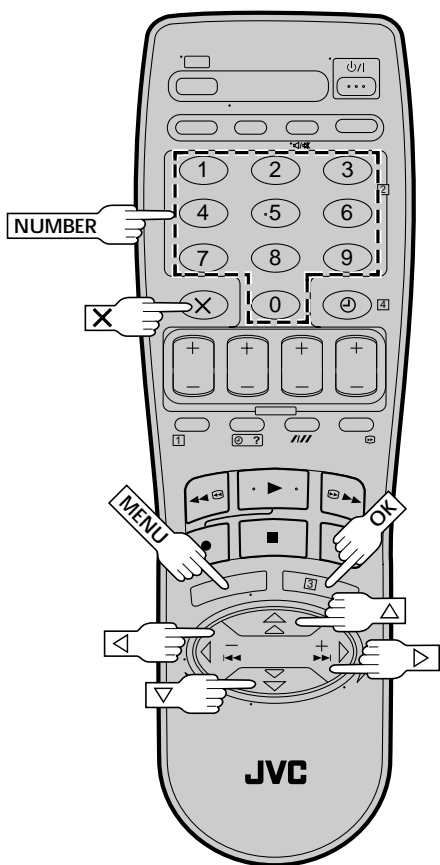

### ATTENTION

Guide Program numbers are not set when channels are stored manually. If an attempt is made at timer programming with VIDEO Plus+ in this state, the "GUIDE PROG SET" screen appears; set the Guide Program numbers on this screen. ☞ "ATTENTION – Regarding Guide Program Number Set" on pg. 13. Or perform "Guide Program Number Set" (☞ pg. 40).

# 1

### ACCESS MAIN MENU SCREEN

Press **MENU**.

# 2

### ACCESS CONFIRMATION SCREEN

Press  $\Delta \nabla$  to move the highlight bar (pointer) to "MANUAL CH SET", then press **OK** or  $\triangleright$ . The Confirmation screen appears.

# 3

### SELECT POSITION

Press  $\Delta \nabla \triangleleft \triangleright$  until an open position in which you want to store a channel begins blinking, then press **OK**. The Manual Channel Set screen appears.

(Ex.) To store in position 6.

PR	CH	ID	PR	CH	ID
01	26	BBC1	08	----	----
02	33	BBC2	09	----	----
03	23	ITV	10	----	----
04	30	CH4	11	----	----
05	37	CH5	12	----	----
06	----	----	13	----	----
07	----	----	14	----	----

[ $\Delta \nabla \triangleleft \triangleright$ ]  
 $\rightarrow$  [OK] : EDIT  
 $\rightarrow$  [X] : DELETE  
 [MENU] : EXIT

The blueback screen and the programme currently being broadcast by the selected channel appear alternately for 8 seconds each.

# 4

### INPUT CHANNEL

Press the **NUMBER** keys to input the channel number you want to store.

- To input the registered station name (ID – ☞ pg. 37), press  $\triangleright$  until "----" (ID setting) begins blinking, then press  $\Delta \nabla$ .
- For fine tuning adjustment, press  $\triangleright$  until "+/-" begins blinking, then press  $\Delta \nabla$ . While tuning, "+" or "-" appears.

PR	CH	ID	FINE
06	CH21	----	+/-

[0-9] : SELECT  
 $\left[ \triangleleft \triangleright \right]$  : CURSOR  $\leftrightarrow$   
 [OK] : OK  
 [MENU] : EXIT

The blueback screen and the programme currently being broadcast by the selected channel appear alternately for 8 seconds each.

### ENTER NEW CHANNEL INFORMATION

Press **OK** and the Confirmation screen appears.

- Repeat steps 3 through 5 as necessary.

# 5

### CLOSE CONFIRMATION SCREEN

Press **MENU**.

# 6

- To change positions, see "Change Station Preset Position" (☞ pg. 35).
- If you wish to set station names other than the ones registered in your recorder, ☞ "Set Stations (B)" on page 36.

## Delete A Channel

Perform steps 1 and 2 of "Storing Channels Manually" on page 34 to access the Confirmation screen before continuing.

- 1** **SELECT ITEM**  
Press  $\Delta \nabla \triangleleft \triangleright$  until the item you want to delete begins blinking.
- 2** **DELETE CHANNEL**  
Press **X**.
  - The item directly beneath the cancelled one moves up one line.
  - Repeat steps 1 and 2 as necessary.
- 3** **CLOSE CONFIRMATION SCREEN**  
Press **MENU**.

## Change Station Preset Position

Perform steps 1 and 2 of "Storing Channels Manually" on page 34 to access the Confirmation screen before continuing.

- 1** **SELECT ITEM**  
Press  $\Delta \nabla \triangleleft \triangleright$  until the item you want to move begins blinking. Then press **OK** and the station name (ID) and its channel (CH) number begin blinking.
  - 2** **SELECT NEW POSITION**  
Press  $\Delta \nabla \triangleleft \triangleright$  to move the station to the new preset position, then press **OK**.  
Example: If you moved the station in position 4 to position 2, the stations originally in positions 2 and 3 each move down one space.
- | PR | CH   | ID   | PR | CH   | ID   | PR | CH   | ID   | PR | CH   | ID   |
|----|------|------|----|------|------|----|------|------|----|------|------|
| 01 | 26   | BBC1 | 08 | ---- | ---- | 01 | 26   | BBC1 | 08 | ---- | ---- |
| 02 | 23   | ITV  | 09 | ---- | ---- | 02 | 33   | BBC2 | 09 | ---- | ---- |
| 03 | 30   | CH4  | 10 | ---- | ---- | 03 | 23   | ITV  | 10 | ---- | ---- |
| 04 | 33   | BBC2 | 11 | ---- | ---- | 04 | 30   | CH4  | 11 | ---- | ---- |
| 05 | 37   | CH5  | 12 | ---- | ---- | 05 | 37   | CH5  | 12 | ---- | ---- |
| 06 | ---- | ---- | 13 | ---- | ---- | 06 | ---- | ---- | 13 | ---- | ---- |
| 07 | ---- | ---- | 14 | ---- | ---- | 07 | ---- | ---- | 14 | ---- | ---- |
- [ $\Delta \nabla \triangleleft \triangleright$ ]: MOVE  
 [X]: MANUAL CH SET  
 [MENU]: EXIT

➔

[ $\Delta \nabla \triangleleft \triangleright$ ]: MOVE → [X]  
 [MENU]: EXIT
- Repeat steps 1 and 2 as necessary.
  - 3** **CLOSE CONFIRMATION SCREEN**  
Press **MENU**.

## Fine-Tuning Channels Already Stored

Perform steps 1 and 2 of "Storing Channels Manually" on page 34 to access the Confirmation screen before continuing.

- 1** **SELECT CHANNEL TO FINE-TUNE**  
Press  $\Delta \nabla \triangleleft \triangleright$  until the channel you want to tune begins blinking.
- 2** **ACCESS MANUAL CHANNEL SET SCREEN**  
Press **OK** twice. The Manual Channel Set screen appears.
- 3** **PERFORM TUNING**  
Press  $\triangleright$  until "+/-" begins blinking, then press  $\Delta \nabla$  until the picture is clearest. Then press **OK**.
  - The Confirmation screen appears.
  - Repeat steps 1 through 3 as necessary.
- 4** **CLOSE CONFIRMATION SCREEN**  
Press **MENU**.

**ATTENTION**

If channel positions are changed or deleted, the Guide Program numbers that have been set are reset.

- Example 1: If a channel is deleted, all the Guide Program numbers are reset.
- Example 2: If a channel is changed from position 4 to position 2, the Guide Program numbers above position 4 are reset.
- Example 3: If a channel is changed from position 4 to position 6, the Guide Program numbers above position 6 are reset.

\* In Examples 2 and 3, if the channel is moved to position 10 before **OK** is pressed, the Guide Program numbers above position 10 are reset.

If an attempt is made at timer programming with VIDEO Plus+ in this state, the "GUIDE PROG SET" screen appears; set the Guide Program numbers on this screen.

☞ "ATTENTION – Regarding Guide Program Number Set" on pg. 13.

Or perform "Guide Program Number Set" (☞ pg. 40).

## Set Stations (A)

Set station names that are registered in your recorder.

Perform steps 1 and 2 of "Storing Channels Manually" on page 34 to access the Confirmation screen before continuing.

### 1 SELECT ITEM

Press  $\Delta \nabla \triangleleft \triangleright$  until the item you want to set begins blinking.

### 2 ACCESS MANUAL CHANNEL SET SCREEN

Press **OK** twice.

### 3 SELECT NEW STATION

Press  $\triangleright$  until the station name (ID) begins blinking, then press  $\Delta \nabla$  until the new station's name (ID) you want to store begins blinking.

Registered station names (see pg. 37) appear as you press  $\Delta \nabla$ .

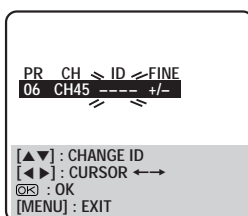

### 4 SWITCH STATIONS

Press **OK**.

- The Confirmation screen appears.
- Repeat steps 1 through 4 as necessary.

### 5 CLOSE CONFIRMATION SCREEN

Press **MENU**.

## Set Stations (B)

Set station names other than the ones registered in your recorder.

Perform steps 1 and 2 of "Storing Channels Manually" on page 34 to access the Confirmation screen and then perform step 1 and 2 of "Set Stations (A)" on the left before continuing.

### 1 SELECT STATION NAME CHARACTER

Press  $\triangleright$  until the first letter of the station name begins blinking.

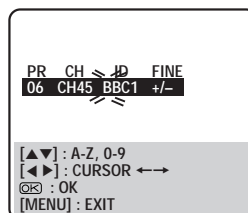

### 2 ENTER NEW CHARACTER

Press  $\Delta \nabla$  to cycle through the characters (A-Z, 0-9, -, \*, +, (space)) and stop when the desired character is indicated, then press  $\triangleright$  to enter. Enter the remaining characters the same way (maximum of 4). After entering all characters, press **OK**.

- The Confirmation screen appears.
- If you make a mistake, press  $\triangleleft$  until the incorrect character begins blinking. Then enter the correct character by pressing  $\Delta \nabla$ .

### 3 CLOSE CONFIRMATION SCREEN

Press **MENU**.



## TV Station And ID List

STATION NAME	ID*
Anglia TV	ANGL
ARD	ARD
ARTE	ARTE
BBC Group	BBC
BBC1	BBC1
BBC2	BBC2
Berlin 1	BLN1
Berlin 2	BLN2
Border TV	BORD
Bayern1	BR1
Bayern3	BR3
BRT1	BRT1
BRT2	BRT2
Children Ch	CHLD
Canal +	CH+
CNN	CNN
Channel TV	CHNL
Central TV	CNTR
Channel 4	CH 4
Channel 5	CH 5
DRS	DRS
DR TV	DRTV
DSF	DSF
Euronews	EURN
Euronews	EURO
Eurosports	EURS
France1	FR1
France2	FR2
France3	FR3
Granada TV	GRNA
Grampian TV	GRMP
Hessen1	HR1
Hessen3	HR3
HRT	HRT
HTV	HTV
ITV Network	ITV
Kabelkanal	KABL
London	LNDN
MDR	MDR
MTV	MTV
Nord3	N3
NDR1	NDR1
NDR3	NDR3
NED1	NED1
NED2	NED2
NED3	NED3
Network 2	NET2
NRK	NRK
N-TV	N-TV
Offener Kanal	OKAN
ORF1	ORF1
ORF2	ORF2
ORF3	ORF3
OWL 3	OWL3
Premiere	PRMI
PR07	PR07
RAI1	RAI1
RAI2	RAI2
RAI3	RAI3
RB1	RB1
RB3	RB3
Rikisutvarpid-S	RKPS
RTBF 1	RTB1
RTBF 2	RTB2
RTE 1	RTE1
RTL	RTL
RTL 2	RTL2
RTP	RTP

STATION NAME	ID*
SAT	SAT
SAT 1	SAT1
Scottish TV	SCOT
SC4	SC4
SDR	SDR
SDR1	SDR1
SFB1	SFB1
SFB3	SFB3
SKY	SKY
Sky One	SKY1
Sky Net	SKYN
Sport	SPRT
SR 1	SR1
Super RTL	SRTL
STV Test	STVT
STV 1	STV1
STV 2	STV2
Suedwest3	SWR
SWF 1	SWF1
Schweiz4	SWZ4
TYNE TEES	TEES
Text	TEXT
TF1	TF1
TNT int	TNT
TRT int	TRT
TSI	TSI
TSR	TSR
TSW	TSW
TVE	TVE
TV Polonia	TVPA
TVP 1	TVP1
TVP 2	TVP2
TVS	TVS
TV2	TV2
TV5	TV5
Tele Zurich	TZUR
Ulster TV	ULST
Veronica	VERN
VIVA	VIVA
VIVA2	VIV2
VOX	VOX
VTM	VTM
VT4	VT4
West1	WDR1
West3	WDR3
YLE 1	YLE1
YLE 2	YLE2
Yorkshire TV	YORK
ZDF	ZDF
Zurich 1	ZUR1
3SAT	3SAT

\* The "ID" abbreviation is what is shown on-screen in lieu of the station name. The "ID" abbreviation is listed in the Confirmation screen and is displayed on the TV screen each time the recorder is tuned to a different station.

## TV Station Channel Number Guide

For customers in the U.K.

Only the main stations are listed. There are in addition many relay stations, and full lists are available from the BBC and ITV.

	BBC1	BBC2	ITV	CH4	CH5		BBC1	BBC2	ITV	CH4	CH5
<b>London &amp; South-East</b>						<b>North-West</b>					
Bluebell Hill .....	40	46	43	65	—	Caldbeck .....	30	34	28	32	56
Crystal Palace .....	26	33	23	30	37	Winter Hill .....	55	62	59	65	48
Dover .....	50	56	66	53	—	<b>North-East</b>					
Heathfield .....	49	52	64	67	—	Bilsdale West Moor .....	33	26	29	23	35
Oxford .....	57	63	60	53	49	Chatton .....	39	45	49	42	—
<b>South-West</b>						Pontop Pike .....	58	64	61	54	68
Beacon Hill .....	57	63	60	53	—	<b>Scotland</b>					
Caradon Hill .....	22	28	25	32	—	Angus .....	57	63	60	53	—
Huntshaw Cross .....	55	62	59	65	67	Black Hill .....	40	46	43	50	37
Redruth .....	51	44	41	47	37	Sandale .....	22	—	—	—	—
Stockland Hill .....	33	26	23	29	—	Caldbeck .....	—	34	28	32	56
Channel Islands						Creigkelly .....	31	27	24	21	48
Fremont Point .....	51	44	41	47	—	Darvel .....	33	26	23	29	35
<b>South</b>						Durriss .....	22	28	25	32	67
Hannington .....	39	45	42	66	35	Eitshal .....	33	26	23	29	—
Midhurst .....	61	55	58	68	—	Keelylang Hill .....	40	46	43	50	—
Rowridge .....	31	24	27	21	—	Knock More .....	33	26	23	29	—
<b>West</b>						Rosemarkie .....	39	45	49	42	67
Mendip .....	58	64	61	54	37	Rumster Forest .....	31	27	24	21	—
<b>East</b>						Selkirk .....	55	62	59	65	52
Sandy Heath .....	31	27	24	21	39	<b>Wales</b>					
Sudbury .....	51	44	41	47	35	Blaenplwyf .....	31	27	24	21	56
Tacolneston .....	62	55	59	65	52	Carmel .....	57	63	60	53	—
<b>Midlands</b>						Llanddona .....	57	63	60	53	—
Ridge Hill .....	22	28	25	32	35	Moel-y-Parc .....	52	45	49	42	—
Sutton Coldfield .....	46	40	43	50	37	Presely .....	46	40	43	50	37
The Wrekin .....	26	33	23	29	35	Wenvoe .....	44	51	41	47	—
Waltham .....	58	64	61	54	35	<b>Northern Ireland</b>					
<b>North</b>						Brougher Mountain .....	22	28	25	32	—
Belmont .....	22	28	25	32	56	Divis .....	31	27	24	21	37
Emley Moor .....	44	51	47	41	37	Limavady .....	55	62	59	65	—

# Clock Set

Turn on the TV and select the VIDEO channel (or AV mode).

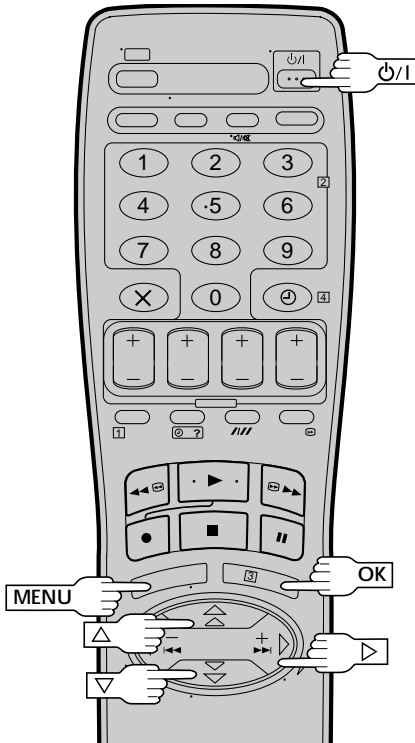

## Just Clock

The Just Clock function provides accurate time keeping through automatic adjustments at regular intervals, by reading data from a PDC signal.

The Just Clock option can be set "ON" or "OFF" at the Clock Set screen (the default setting is "ON"). Press **OK** until the Just Clock setting begins blinking, then press  $\Delta\nabla$  to change the setting.

**IMPORTANT:** If you turn the Just Clock function off, the accuracy of your recorder's built-in clock may be impaired, which could adversely affect timer recording.

## NOTES:

- Just Clock (when set to "ON") adjusts the recorder's built-in clock every hour, except for 23:00, 0:00, 1:00 and 2:00.
- Just Clock is not effective when . . .
  - the recorder's power is on.
  - the recorder is in the Timer mode.
  - a difference of more than 3 minutes exists between the built-in clock's time and the actual time.
  - the recorder is in the Auto Satellite Prog Rec mode (see pg. 22).
- If Just Clock is set to "ON", the recorder's clock is automatically adjusted at the start/end of Summer Time.
- Just Clock may not function properly in poor reception conditions.

## IMPORTANT

If you performed Auto Set Up (see pg. 6) or Auto Channel Set (see pg. 32), without ever having set the clock previously, the recorder's built-in clock is also set automatically. Perform the following steps only if —

- Auto Clock Set has not been performed correctly by Auto Set Up or Auto Channel Set.
- or
- the recorder's memory backup has expired.
- or
- you want to change Just Clock setting (see "Just Clock" in the left column).

## 1 TURN THE RECORDER ON

Press  $\text{power}/\text{I}$ .

## 2 ACCESS MAIN MENU SCREEN

Press **MENU**.

## 3 ACCESS INITIAL SET SCREEN

Move the highlight bar (pointer) to "INITIAL SET" by pressing  $\Delta\nabla$ , then press **OK** or  $\triangleright$ .

## 4 ACCESS CLOCK SET SCREEN

Move the highlight bar (pointer) to "CLOCK SET" by pressing  $\Delta\nabla$ , then press **OK** or  $\triangleright$ . The Clock Set screen appears.

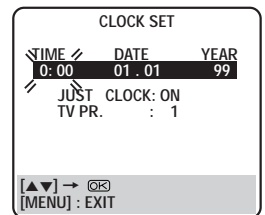
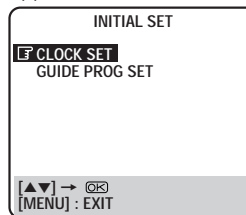

## 5 SET DATE AND TIME

Press  $\Delta\nabla$  to set the time, then press **OK** or  $\triangleright$ . The "DATE" display begins blinking. Repeat the same procedure to set the date and year.

- When you set the time, press and hold  $\Delta\nabla$  to change the time by 30 minutes.
- When you set the date, press and hold  $\Delta\nabla$  to change the date by 15 days.

## 6 SET JUST CLOCK

The default setting is "ON". Set as desired by pressing  $\Delta\nabla$ , then press **OK** or  $\triangleright$ .

- For the Just clock function, see "Just Clock" on the left.
- If you set to "OFF", you can disregard the next step as you won't be able to receive regular clock adjustments.

## 7 SET CLOCK DATA SOURCE PRESET

The recorder is preset to receive clock setting and adjustment data from preset position 1. Press  $\Delta\nabla$  to set the preset position to the number representing the station transmitting clock setting data (BBC1, BBC2, etc.), then press **OK** or  $\triangleright$ .

## 8 START CLOCK OPERATION

Press **MENU**.

# VIDEO Plus+ Setup

## IMPORTANT

Normally, Auto Set Up (pg. 6) or Auto Channel Set (pg. 32) sets the Guide Program Numbers automatically. You need to set the Guide Program Numbers manually only in the following cases.

- When timer-programming with VIDEO Plus+, the preset position, where the station you wish to record is received on your recorder, is not selected or when you add a channel after Auto Set Up or Auto Channel Set has taken place.
  - Set the Guide Program Number for that station manually.
- When you delete a channel or change preset positions manually after Auto Set Up or Auto Channel Set has taken place.
  - Set the Guide Program Numbers for all the receivable stations manually.
- When you wish to timer-record a satellite programme with VIDEO Plus+.
  - Set the Guide Program Numbers for all satellite broadcasts received on your satellite receiver.

Turn on the TV and select the VIDEO channel (or AV mode).

## Guide Program Number Set

1

### ACCESS MAIN MENU SCREEN

Press **MENU**.

2

### ACCESS INITIAL SET SCREEN

Press  $\Delta \nabla$  to move the highlight bar (pointer) to "INITIAL SET", then press **OK** or  $\triangleright$ .

3

### ACCESS GUIDE PROG SET SCREEN

Press  $\Delta \nabla$  to move the highlight bar (pointer) to "GUIDE PROG SET", then press **OK** or  $\triangleright$ .

4

### ENTER GUIDE PROG NUMBER

Press  $\Delta \nabla$  or **NUMBER** keys to enter the Guide Program number for the desired station as shown in the TV listings. Then press **OK** or  $\triangleright$ .

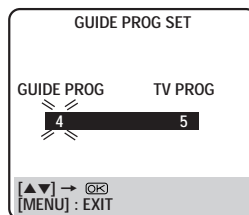

(Ex.) When inputting the Guide Program number 4 for CH4.

5

### ENTER RECEIVING PRESET POSITION NUMBER

Press  $\Delta \nabla$  or **NUMBER** keys to input the number of the recorder's preset position on which the Guide Program number's broadcast is received. Then press **OK** or  $\triangleright$ .

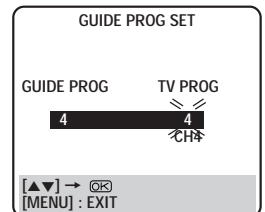

(Ex.) If CH4 is received on preset position 4.

- If the satellite broadcast is received on your recorder's auxiliary channel "L-2", select "L-2" for the preset position.
- Repeat steps 4 and 5 as necessary.

6

### RETURN TO NORMAL SCREEN

Press **MENU**.

## Guide Program Number

"Guide Program (GUIDE PROG) number" refers to the assigned TV station numbers, according to broadcast area, for VIDEO Plus+ timer recording. The Guide Program numbers can be found in most TV listings.

# Questions And Answers

## **PLAYBACK**

- Q. What happens if the end of the tape is reached during playback or search?**  
A. The tape is automatically rewound to the beginning.  
.....
- Q. Can the video recorder indefinitely remain in the still mode?**  
A. No. It stops automatically after 5 minutes to protect the heads.  
.....
- Q. During search, slow, still and frame-by-frame playback, I can't hear any audio. What's the problem?**  
A. This is normal.  
.....
- Q. When returning from variable-speed search to normal playback, the picture is disturbed. Should I be concerned about this?**  
A. No, it is normal.  
.....
- Q. Noise bars appear during variable-speed search. What's the problem?**  
A. This is normal.  
.....
- Q. Other than preventing further recording, what effect does removing the Record Safety tab have?**  
A. It disables marking of index codes.  
.....
- Q. Sometimes, during Index Search, the video recorder can't find the programme I want to see. Why not?**  
A. There may be index codes too close together.  
.....

## **RECORDING**

- Q. When I pause and then resume a recording, the end of the recording before the pause is overlapped by the beginning of the continuation of recording. Why does this happen?**  
A. This is normal. It reduces distortion at the pause and resume points.  
.....
- Q. Can the video recorder indefinitely remain in the Record-Pause mode?**  
A. No. The video recorder shuts off automatically after 5 minutes to protect the heads.  
.....
- Q. What happens if the tape runs out during recording?**  
A. The video recorder automatically rewinds it to the beginning or, if Timer Recording, the cassette is ejected.  
.....

## **TIMER RECORDING**

- Q. "○" and "⊕" remain lit on the display panel. Is there a problem?**  
A. No. This is a normal condition for a timer recording in progress.  
.....
- Q. Can I programme the timer while I'm watching a tape or a TV broadcast?**  
A. You won't see the picture as it is replaced by the on-screen menu, but the audio from the program or tape you're viewing can be heard.  
.....
- Q. Is it possible to timer-record a TV programme broadcast in 2000?**  
A. Yes, it is possible.  
.....

### **ATTENTION**

This recorder contains microcomputers. External electronic noise or interference could cause malfunctioning. In such cases, switch the recorder off and unplug the mains power cord. Then plug it in again and turn the recorder on. Take out the cassette. After checking the cassette, operate the unit as usual.

# Troubleshooting

Before requesting service for a problem, use this chart to see if you can correct the trouble yourself. Small problems are often easily corrected, and this can save you the trouble of sending your video recorder off for repair.

## POWER

SYMPTOM	POSSIBLE CAUSE	CORRECTIVE ACTION
1. No power is applied to the recorder.	<ul style="list-style-type: none"> <li>The mains power cord is disconnected.</li> </ul>	Connect the mains power cord.
2. The clock is functioning properly, but the recorder cannot be powered.	<ul style="list-style-type: none"> <li>"⊖" is displayed on the display panel with Auto Timer set to "OFF".</li> </ul>	Press the ⊖ button to turn the "⊖" indicator off.
3. The remote control won't function.	<ul style="list-style-type: none"> <li>The batteries are discharged.</li> </ul>	Replace the dead batteries with new ones.

## TAPE TRANSPORT

SYMPTOM	POSSIBLE CAUSE	CORRECTIVE ACTION
1. The tape does not run during recording.	<ul style="list-style-type: none"> <li>"⏏" is displayed on the display panel.</li> </ul>	Press <b>PLAY</b> to turn the "⏏" indicator off.
2. The tape will not rewind or fast-forward.	<ul style="list-style-type: none"> <li>The tape is already fully rewound or fast-forwarded.</li> </ul>	Check the cassette.

## PLAYBACK

SYMPTOM	POSSIBLE CAUSE	CORRECTIVE ACTION
1. The playback picture does not appear while the tape is running.	<ul style="list-style-type: none"> <li>If you're using the RF OUT connection . . . . . the TV receiver's channel selector is not set to the VIDEO channel. . . . . the recorder's VIDEO channel has not been correctly set.</li> <li>If you're using the AV connection, the TV receiver is not set to the AV mode.</li> </ul>	<p>If you are using the RF OUT connection . . . . . set the TV receiver to the VIDEO channel. (☞ pg. 6)</p> <p>. . . Perform "Video Channel Set" (☞ pg. 30)</p> <p>If you are using the AV connection, set the TV to its AV mode.</p>
2. Noise appears during visual search.	<ul style="list-style-type: none"> <li>This is normal.</li> </ul>	
3. Noise appears during normal playback.	<ul style="list-style-type: none"> <li>The automatic tracking mode is engaged.</li> </ul>	Try manual tracking (☞ pg. 17).
4. The playback picture is blurred or interrupted while TV broadcasts are clear.	<ul style="list-style-type: none"> <li>The video heads may be dirty.</li> </ul>	Consult your JVC dealer.
5. Breaks are noticeable in Hi-Fi soundtrack.	<ul style="list-style-type: none"> <li>Automatic tracking is engaged.</li> </ul>	Engage and adjust tracking manually. (☞ pg. 17)

## RECORDING













SYMPTOM	POSSIBLE CAUSE	CORRECTIVE ACTION
1. Recording cannot be started.	<ul style="list-style-type: none"> <li>There is no cassette loaded, or the cassette loaded has had its Record Safety tab removed.</li> </ul>	Insert a cassette, or using adhesive tape, reseal the slot where the tab was removed.
2. TV broadcasts cannot be recorded.	<ul style="list-style-type: none"> <li>"L-1", "L-2" or "F-1" has been selected as the input mode.</li> </ul>	Set to the desired preset.
3. Tape-to-tape editing is not possible.	<ul style="list-style-type: none"> <li>The source (another video recorder, camcorder) has not been properly connected.</li> <li>All necessary power switches have not been turned on.</li> <li>The input mode is not correct.</li> </ul>	<p>Confirm that the source is properly connected.</p> <p>Confirm that all units' power switches are turned on.</p> <p>Set the input mode to "L-1", "L-2" or "F-1".</p>

4. Camcorder recording is not possible.



- The camcorder has not been properly connected.
- The input mode is not correct.

Confirm that the camcorder is properly connected.  
Set the input mode to "F-1".

## TIMER RECORDING

SYMPTOM	POSSIBLE CAUSE	CORRECTIVE ACTION
1. Timer recording won't work.	<ul style="list-style-type: none"> <li>• The clock and/or the timer have been set incorrectly.</li> <li>• The timer is not engaged.</li> </ul>	Re-perform the clock and/or timer settings. Press  and confirm that "  " is displayed on the display panel.
2. Timer programming is not possible.	<ul style="list-style-type: none"> <li>• Timer recording is in progress.</li> </ul>	Timer programming can't be performed while a timer recording is in progress. Wait until it finishes.
3. "  " and "  " on the display panel won't stop blinking.	<ul style="list-style-type: none"> <li>• The timer is engaged but there's no cassette loaded.</li> </ul>	Load a cassette with the Record Safety tab intact, or cover the hole using adhesive tape.
4. The cassette is automatically ejected, and "  " and "  " on the display panel won't stop blinking.	<ul style="list-style-type: none"> <li>• The loaded cassette has had its Record Safety tab removed.</li> </ul>	Remove the cassette and cover the hole with adhesive tape, or insert a cassette with the Record Safety tab intact.
5. "  " blinks for 10 seconds and the Timer mode is disengaged.	<ul style="list-style-type: none"> <li>•  has been pressed when there are no programs in memory, or the timer record information has been programmed incorrectly.</li> </ul>	Check the programmed data and re-programme as necessary, then press  again.
6. The cassette is automatically ejected, the power shuts off and "  " and "  " won't stop blinking.	<ul style="list-style-type: none"> <li>• The end of the tape was reached during timer recording.</li> </ul>	The programme may not have been recorded in its entirety. Next time make sure you have enough time on the tape to record the entire programme.
7. VIDEO Plus+ does not timer-record properly.	<ul style="list-style-type: none"> <li>• The recorder's preset positions have been set incorrectly.</li> </ul>	Refer to "Guide Program Number Set" and re-perform the procedure (  pg. 40).

## OTHER PROBLEMS

SYMPTOM	POSSIBLE CAUSE	CORRECTIVE ACTION
1. Whistling or howling is heard from the TV during camcorder recording.	<ul style="list-style-type: none"> <li>• The camcorder's microphone is too close to the TV.</li> <li>• The TV's volume is too high.</li> </ul>	Position the camcorder so its microphone is away from the TV. Turn the TV's volume down.
2. When scanning channels, some of them are skipped over.	<ul style="list-style-type: none"> <li>• Those channels have been designated to be skipped.</li> </ul>	If you need the skipped channels, restore them (  pg. 34).
3. The preset cannot be changed.	<ul style="list-style-type: none"> <li>• Recording is in progress.</li> </ul>	Press <b>PAUSE</b> to pause the recording, change presets, then press <b>PLAY</b> to resume recording.
4. Channel settings that were made manually seem to have changed or disappeared.	<ul style="list-style-type: none"> <li>• After the manual settings were made, Auto Channel Set was performed.</li> </ul>	Perform manual setting again.
5. No channels are stored in the recorder's memory.	<ul style="list-style-type: none"> <li>• The TV aerial cable was not connected to the recorder when Auto Set Up was performed.</li> </ul>	Connect the TV aerial cable to the recorder properly and turn off the recorder power once, then turn the recorder power back on again. The recorder will try Auto Set Up again (  pg. 6).



# Index

## FRONT VIEW

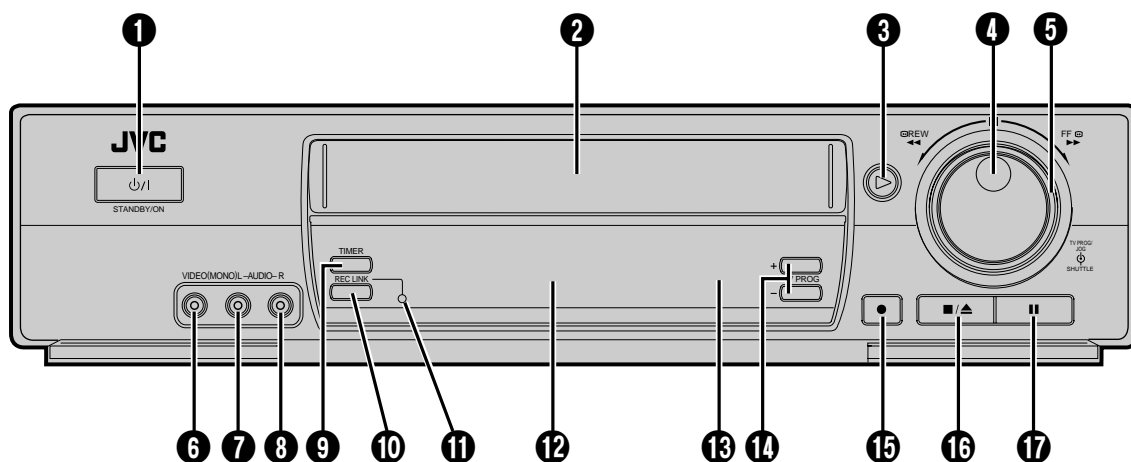

- ❶ **STANDBY/ON**  $\phi$ /I Button turns recorder on/off (loading a cassette also turns power on).
- ❷ **Cassette Loading Slot** is where cassette is inserted; door closes, "cassette loaded" mark lights up on front display panel.
- ❸ **PLAY** Button plays back tape  $\Rightarrow$  pg. 8; cancels Pause, Still, Slow, Search modes.  $\Rightarrow$  pg. 9
- ❹ **TV PROG Dial** scans to desired preset position during Stop mode.  $\Rightarrow$  pg. 10  
**JOG Dial** plays back frame by frame during Still or Play mode.  $\Rightarrow$  pg. 9
- ❺ **SHUTTLE Ring** rewinds or fast-forwards tape during Stop mode  $\Rightarrow$  pg. 8; performs forward and reverse slow-motion and search during Still or Play mode.  $\Rightarrow$  pg. 9
- ❻ **VIDEO Input Connector** enables easy connection of video output from another recorder or camcorder for editing.  $\Rightarrow$  pg. 25
- ❼ **AUDIO Input Connector [L]** enables easy connection of audio output (mono) from another recorder, camcorder or other source for editing.  $\Rightarrow$  pg. 25
- ❽ **AUDIO Input Connector [R]** enables easy connection of audio output (Hi-Fi) from another recorder, camcorder or other source for editing.  $\Rightarrow$  pg. 25
- ❾ **TIMER** Button engages timer standby mode.  $\Rightarrow$  pg. 13, 15
- ❿ **REC LINK** Button enables/disables the Auto Satellite Prog Rec mode.  $\Rightarrow$  pg. 23
- ⓫ **REC LINK Indicator** lights up during Auto Satellite Prog Rec mode.  $\Rightarrow$  pg. 23
- ⓬ **Display Panel** provides clear view of various displays and indicators.  $\Rightarrow$  pg. 45
- ⓭ **Infrared Beam Receiving Window** is where remote control should be aimed when in use.
- ⓮ **TV PROG +/- Buttons** select a preset position.  $\Rightarrow$  pg. 10
- ⓯ **RECORD** Button starts regular recording (press once), Instant Timer Recording (press twice); sets duration of ITR.  $\Rightarrow$  pg. 10, 11
- ⓰ **STOP/EJECT** Button stops tape; ejects tape during Stop mode.  $\Rightarrow$  pg. 8
- ⓱ **PAUSE** Button stops tape temporarily during recording  $\Rightarrow$  pg. 10; stops tape temporarily during playback; plays back frame by frame with each additional press.  $\Rightarrow$  pg. 9

## REAR VIEW

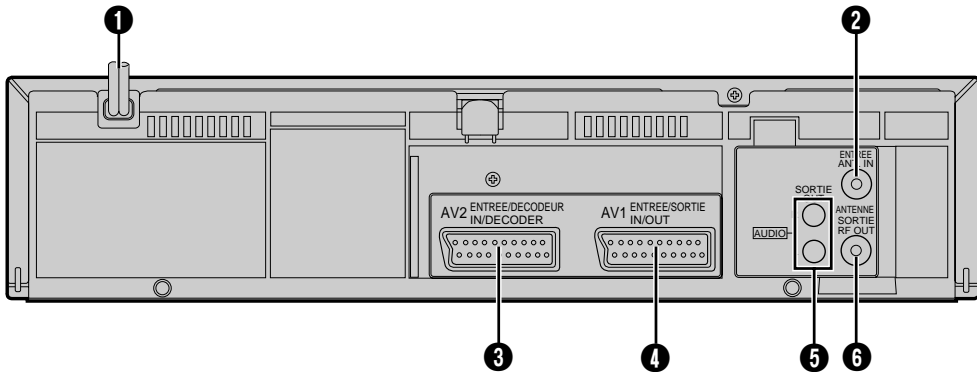

- ❶ **Mains Power Cord** supplies power to recorder. ☞ pg. 5
- ❷ **ANT. IN Connector** enables connection of aerial. ☞ pg. 5
- ❸ **AV2 IN/DECODER Connector** enables connection of satellite receiver or second recorder; input recordable when "L-2" selected. ☞ pg. 22, 24
- ❹ **AV1 IN/OUT Connector** enables AV connection to TV or second recorder; input recordable when "L-1" selected. ☞ pg. 5, 24
- ❺ **AUDIO OUT (L/R) Connectors** enable connection of audio cassette recorder, TV or second video recorder for dubbing. ☞ pg. 29
- ❻ **RF. OUT Connector** enables connection to aerial terminal of TV receiver. ☞ pg. 5

## DISPLAY PANEL

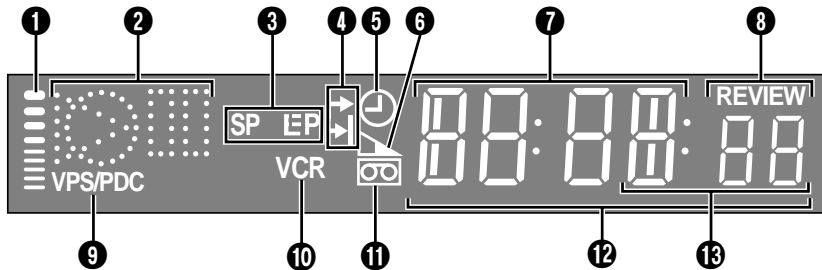

- ❶ **B.E.S.T. Picture System Display** lights from bottom to top while B.E.S.T. is active. ☞ pg. 18
  - ❷ **Symbolic Mode Indicators**
- |   |  |               |  |
|---|--|---------------|--|
| PLAY:<br>FF/REW VARIABLE<br>SHUTTLE SEARCH: |  | STILL:        |  |
|   |  | SLOW:         |  |
|   |  | RECORD:       |  |
|   |  | RECORD PAUSE: |  |
- ❸ **Tape Speed Indicators** display mode of recording; light during Record or Play mode. ☞ pg. 10  
\* EP is only for NTSC playback.
  - ❹ **Programme Time Indicators** show the programme start time (▶) and the programme stop time (▶) for timer-recording. ☞ pg. 14
  - ❺ **"Timer" Indicator** lights when ⊖ has been pressed to engage Timer mode. ☞ pg. 13, 15
  - ❻ **Tape Remaining Time Indicator** displays time remaining on tape when certain buttons are pressed. ☞ pg. 11
  - ❼ **Channel Display** shows preset position where the station currently being received is stored.  
**Clock Display** shows current time. ☞ pg. 7
  - ❽ **Instant REVIEW Indicator** blinks after timer-recording and shows how many programmes have been timer-recorded. ☞ pg. 19
  - ❾ **PDC Indicator** lights when PDC has been engaged for timer recording. ☞ pg. 13, 15  
\* VPS (Video Programme System) recording is not currently available in the U.K. and not possible with this recorder.
  - ❿ **VCR Indicator** lights when the video recorder is in the video mode. At this point, the TV automatically enters AV mode. ☞ pg. 8
  - ⓫ **"Cassette Loaded" Mark** lights once a cassette is inserted; remains lit until cassette ejected.
  - ⓬ **Counter** shows time elapsed since playback or recording began.  
**With displayed**, shows time remaining from current tape position to end of tape (☞ pg. 11). Counter, Preset Position\*, Clock and Tape Remaining Time Display appear alternately when --:-- is pressed.  
\* Preset Position is not displayed during playback.
  - ⓭ **Mode** shows external input mode selected (L-1, L-2 or F-1).

## REMOTE CONTROL

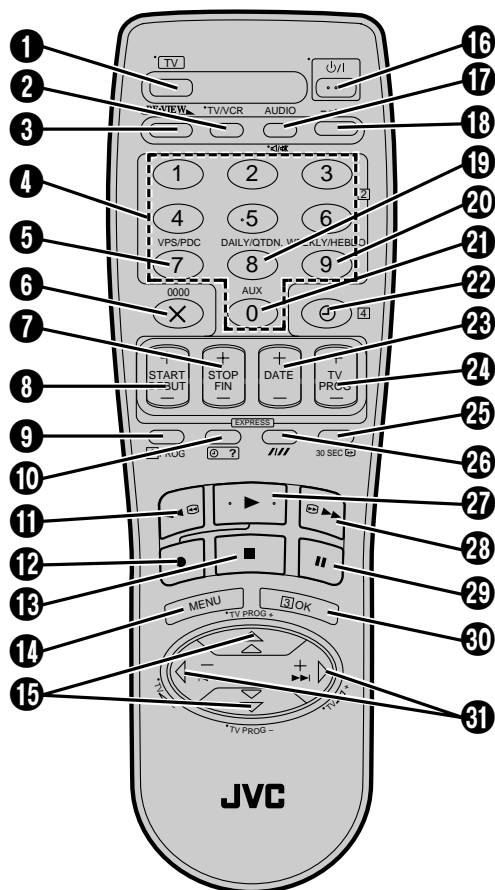

Buttons with a small dot on the left side of the name can also be used to operate your JVC TV while holding down the **TV** button.  
 ☞ "Operating JVC TVs" on page 47.

This remote control transmits A code signals only; it is not applicable to B code signals.

- 1 **TV Button** enables remote control of your JVC TV. ☞ "Operating JVC TVs" on pg. 47
- 2 **TV/VCR Button** switches connected TV's mode between TV and AV. ☞ pg. 8, 10 and "Operating JVC TVs" on pg. 47
- 3 **REVIEW Button** "reviews" timer-recorded programme. ☞ pg. 19
- 4 **NUMBER Keys** are used in preset position selection ☞ pg. 10, VIDEO Plus+ timer programming ☞ pg. 12.
- 5 **PDC Button** enables/disables PDC recording. ☞ pg. 13, 15  
 \* VPS (Video Programme System) recording is not currently available in the U.K. and not possible with this recorder.
- 6 **X Button** cancels timer-programme. ☞ pg. 16
- 7 **0000 Button** resets counter to 0:00:00. ☞ pg. 11
- 8 **STOP +/- Button** inputs programme Stop Time. ☞ pg. 14
- 9 **START +/- Button** accesses Regular Program screen; inputs programme Start Time. ☞ pg. 14
- 10 **PROG Button** accesses VIDEO Plus+ Program screen. ☞ pg. 12
- 11 **? Button** accesses Program screens/displays to check the programme that you have programmed (next programme's information screen appears each time button is pressed). ☞ pg. 16
- 12 **Rewind [REW] Button** rewinds the tape ☞ pg. 8; initiates high-speed reverse search. ☞ pg. 9
- 13 **Record Button** — same as button on recorder. ☞ pg. 10
- 14 **Stop Button** — same as button on recorder. ☞ pg. 8
- 15 **MENU Button** accesses Menu screen. ☞ pg. 18
- 16 **Δ▽ Button** is used for selection in on-screen menus. ☞ pg. 18  
**TV PROG +/-** selects the connected JVC TV's channel. ☞ "Operating JVC TVs" on pg. 47
- 17 **STANDBY/ON ⏻/⏻ Button** — same as button on recorder.
- 18 **AUDIO Button** changes output sound mode. ☞ pg. 20  
**⏻/⏻ (TV Muting) Button** mutes sound of connected JVC TV. ☞ "Operating JVC TVs" on pg. 47
- 19 **--:-- (Display) Button** switches display between clock time, tape remaining time, counter readings, preset position\*. ☞ pg. 11  
 \* Preset position is not displayed during playback.
- 20 **DAILY Button** enables timer recording of daily serials. ☞ pg. 13, 15

- 20 **WEEKLY Button** enables timer recording of weekly serials. ☞ pg. 13, 15
  - 21 **AUX Button** selects recorder's auxiliary input mode. ☞ pg. 24
  - 22 **⊖ Button** engages timer-standby mode. ☞ pg. 13, 15
  - 23 **DATE +/- Button** inputs date of programme for timer recording. ☞ pg. 14
  - 24 **TV PROG +/- Button** — same as button on recorder. ☞ pg. 10
  - 25 **30 SEC Button** initiates a 30-second period of fast-motion playback. ☞ pg. 21
  - 26 **Auto Tracking Button** enables/disables auto tracking mode during playback ☞ pg. 17
  - SP/LP (///) Button** selects tape speed. ☞ pg. 10
  - 27 **Play Button** — same as button on recorder. ☞ pg. 8, 9
  - 28 **Fast Forward [FF] Button** fast-forwards tape ☞ pg. 8; initiates high-speed forward search. ☞ pg. 9
  - 29 **Pause Button** — same as button on recorder. ☞ pg. 9
  - 30 **OK Button** enters selections made in on-screen menus. ☞ pg. 18
  - 31 **◀▶ Button** initiates functions such as Index Search ☞ pg. 19, variable-speed search, frame by frame playback. ☞ pg. 9
- TV ▲ +/--Button** controls volume of connected JVC TV. ☞ "Operating JVC TVs" in the right column.

## How To Use

The remote control can operate most of your video recorder's functions, as well as basic functions of JVC TV sets. (See below.)

- Point the remote control toward the sensor window.
- The maximum operating distance of the remote control is about 8 m.

## Operating JVC TVs

To operate your TV, while holding down the **TV** button, press the corresponding button: **STANDBY/ON** ⏻/⏻, **TV/VCR**, **TV PROG +/-**, **TV ▲ +/-**, **⏻/⏻** (TV Muting).

## NOTES:

- *When inserting the batteries, be sure to insert in the correct directions as indicated under the battery cover.*
- *Depending on the type of JVC TV, there may be cases where some or all functions cannot be operated using the remote control.*
- *If the remote control doesn't work properly, remove its batteries, wait a short time, replace the batteries and then try again.*

# SPECIFICATIONS

## GENERAL

Power requirement	: AC 220 – 240 V~, 50/60 Hz
Power consumption	
Power on	: 20 W
Power off	: 4.5 W
Temperature	
Operating	: 5°C to 40°C
Storage	: -20°C to 60°C
Operating position	: Horizontal only
Dimensions (WxHxD)	: 400 x 94 x 281 mm
Weight	: 3.5 kg
Format	: VHS PAL standard
Maximum recording time	
(SP)	: 240 min. with E-240 video cassette
(LP)	: 480 min. with E-240 video cassette

## VIDEO/AUDIO

Signal system	: PAL-type colour signal and CCIR monochrome signal, 625 lines/50 fields
Recording system	: DA4 (Double Azimuth) helical scan system
Signal-to-noise ratio	: 45 dB
Horizontal resolution	: 250 lines
Frequency range	: 70 Hz to 10,000 Hz (Normal audio) 20 Hz to 20,000 Hz (Hi-Fi audio)
Input/Output	: 21-pin scart connectors (IN/OUT x 1, IN/DECODER x 1) RCA connectors (VIDEO IN x 1, AUDIO IN x 1, AUDIO OUT x 1)

## TUNER/TIMER

TV channel storage capacity	: 99 positions (+AUX position)
Tuning system	: Frequency synthesized tuner
Channel coverage	: UHF channels 21 – 69 (470 – 862 MHz)
Aerial output	: UHF channels 22 – 69 (Adjustable)
Memory backup time	: Approx. 10 min.

## ACCESSORIES

Provided accessories	: RF cable, Infrared remote control unit, "AA" battery x 2
----------------------	--

*Specifications shown are for SP mode unless otherwise specified.*

*E. & O.E. Design and specifications subject to change without notice.*

HR-J765EK

# JVC

VICTOR COMPANY OF JAPAN, LIMITED